



Florida-Friendly Landscaping™ Guide to Plant Selection & Landscape Design

Copyright revised 2022, University of Florida.

This publication was funded in part by FDEP with a Section 319 Nonpoint Source Management Program Grant from the U.S. Environmental Protection Agency.

DISCLAIMER: The mention of a specific product or company is for information purposes only and does not constitute an endorsement of that product or company.

Table of Contents

Introduction

What are Florida-Friendly Landscapes?	4
What is a Florida-Friendly Landscape?.....	7

The Nine Florida-Friendly Landscaping™ Principles	8
--	---

Designing Your Florida-Friendly Landscape

Introduction	11
What if I Live in a Planned Community?	11
Design Scenarios:	
Scenario A: Front Entry	12
Scenario B: Along Walls	14
Scenario C: Along Sidewalks	16
Scenario D: Under Windows.....	18
Scenario E: Along Fences	20
Scenario F: Under Trees	22
Scenario G: Utilities	24
Scenario H: Standing Water	26

Converting Your Yard into a Florida-Friendly Landscape	28
---	----

Ecological Considerations	30
--	----

Landscape Planning Worksheet	32
Five Common Gardening Mistakes	36

Florida-Friendly Landscaping™ Plant List

Introduction	39
Key to Symbols and Abbreviations	41
Large Trees	42
Medium Trees.....	48
Small Trees	52
Large Shrubs.....	60
Small Shrubs.....	74
Vines	78
Groundcovers	82
Grasses.....	86
Palms & Palm-Like Plants.....	88
Ferns	94
Perennials	96
Annuals	108
Turfgrass.....	112
Plant Index	113
Additional Key to Symbols and Abbreviations	127

Additional Information

References	124
Photo Credits.....	124

What Are Florida-Friendly Landscapes?

Florida-Friendly Landscapes protect Florida's unique natural resources by conserving water, reducing waste and pollution, creating wildlife habitat, and preventing erosion. Any landscape can be Florida-Friendly if it is designed and cared for according to the nine Florida-Friendly Landscaping™ principles, which encourage individual expression of landscape beauty.

In 2009, the Florida Legislature found "that the use of Florida-Friendly Landscaping™ and other water

use and pollution prevention measures to conserve or protect the state's water resources serves a compelling public interest and that the participation of homeowners' associations and local governments is essential to the state's efforts in water conservation and water quality protection and restoration." Make your landscape a Florida-Friendly Landscape—do your part to create a more sustainable Florida!





Services

Florida-Friendly Landscaping™ is brought to Floridians by the University of Florida/IFAS Extension Service and the Florida Department of Environmental Protection, in cooperation with the five water management districts. UF/IFAS Extension offers the public the following services in every county in the state at either no charge or for a minimal fee:

- Workshops and classes
- Plant and landscape advice based on current University of Florida research
- Official yard recognition program

The program also offers online resources, including numerous publications, a tutorial for custom landscape design, and a plant database.

Phone: (352) 273-4518

Website: www.floridafriendlylandscaping.com

Please visit our website to find your county Extension office

Thanks to the following individuals for helping to produce this document:

<i>Adrian Hunsberger</i>	<i>Gail Hansen</i>	<i>Sandy Wilson</i>
<i>Alison Fox</i>	<i>Gary Knox</i>	<i>Sarah Graddy</i>
<i>Angela Maraj</i>	<i>Georgia Gelmis</i>	<i>Stephen Brown</i>
<i>Barbra Larson</i>	<i>Glenn Acomb</i>	<i>Sydney Park Brown</i>
<i>Bart Schutzman</i>	<i>Heather Ritchie</i>	<i>Sylvia Durrell</i>
<i>Brian Niemann</i>	<i>Jane Morse</i>	<i>Teresa Watkins</i>
<i>Chris Dewey</i>	<i>Jessica Sullivan</i>	<i>Terril Nell</i>
<i>Claire Lewis</i>	<i>Jim Moll</i>	<i>Terry DelValle</i>
<i>Claudia Larsen</i>	<i>Joan Dusky</i>	<i>Tom MacCubbin</i>
<i>Crysta Gantz</i>	<i>John Bossart</i>	<i>Tom Wichman</i>
<i>Dan Culbert</i>	<i>Jyotsna Sharma</i>	<i>Wendy Wilber</i>
<i>David Sandrock</i>	<i>Kathy Malone</i>	
<i>Dean Rusk</i>	<i>Kim Gabel</i>	
<i>Doug Caldwell</i>	<i>Larry Williams</i>	
<i>Ed Gilman</i>	<i>Marguerite Beckford</i>	
<i>Eileen Tramontana</i>	<i>Mary Duryea</i>	
<i>Emily Eubanks</i>	<i>Michael Scheinkman</i>	
<i>Erick Smith</i>	<i>Michael Thomas</i>	
<i>Erin Alvarez</i>	<i>Patty Connolly</i>	
<i>Esen Momol</i>	<i>Rick Schoellhorn</i>	

What is a Florida-Friendly Landscape?

A Florida-Friendly Landscape is a quality landscape that is designed, installed, and maintained according to the nine Florida-Friendly Landscaping™ principles. The nine principles seek to reduce environmental impact from landscaping by properly applying water, fertilizer, and pesticides, creating wildlife habitat, preventing erosion, recycling yard waste, and employing other practices based on University of Florida research.

Not all Florida-Friendly Landscapes look alike. A wide variety of forms, styles, and types are available to the designer. Florida-Friendly Landscapes may incorporate both native and non-native plants. One Florida-Friendly yard may use a rain garden to filter stormwater runoff, while another may attract pollinators with specific nectar plants. But if cared for according to the nine principles, a Florida-Friendly Landscape can produce aesthetically pleasing, low-maintenance results that may add value to your property while helping to protect the state's natural resources.

The Florida-Friendly Landscaping™ Program

Preserving and protecting Florida's water resources is the focus of the Florida-Friendly Landscaping™ (FFL) Program, which promotes the nine principles with public outreach and education statewide. The FFL Program is a joint venture of the Florida Department of Environmental Protection (FDEP) and the University of Florida Institute of Food and Agricultural Sciences (UF/IFAS). The FFL Program works in cooperation with the state's five water management districts and other agencies and organizations to achieve the common goals of water conservation and water quality protection.

Landscape design & plant Selection

So, how do plant selection and landscape design contribute to saving water and preventing pollution? The first Florida-Friendly

Landscaping™ principle—"Right Plant, Right Place"—involves designing a landscape efficiently and choosing plants that fit the site. This helps reduce maintenance inputs, including irrigation, fertilization, mowing, and application of pesticides, which in turn lowers the risk of pollutants finding their way into ground or surface waters. Keeping excess nitrogen and phosphorus out of the water improves the health of water bodies and by extension the whole ecosystem. This guide will help you to create a landscape that works with the natural environment, rather than against it. Such a landscape, if maintained correctly, will require less money, time, and effort on your part, while still looking healthy and beautiful.

How to use this book

The Florida-Friendly Landscaping™ Guide to Plant Selection & Landscape Design is intended as a companion to *The Florida-Friendly Landscaping™ Handbook for Home Landscapes*. The Handbook is available through your county Extension office or online at <http://ffl.ifas.ufl.edu>. The Handbook describes in detail the nine principles that are the bedrock of the FFL Program. This guide is intended for homeowners who want to take the next step and design their own Florida-Friendly landscapes. Included in this book is information on landscape design strategies, a landscape planning worksheet, and the FFL Plant List containing many of the UF/IFAS-recommended Florida-Friendly plants for each region of the state.

Invasive Species

Invasive plant species pose a significant threat to Florida's natural areas. The UF/IFAS Assessment uses literature-based risk assessment tools to predict the invasion risk of both nonnative species that occur in the state as well as species proposed for introduction. <http://assessment.ifas.ufl.edu/>

The Nine Florida-Friendly Landscaping™ Principles

The nine Florida-Friendly Landscaping™ principles are the cornerstone of the Florida-Friendly Landscaping™ Program. Based on UF/IFAS science, the principles teach homeowners, builders and developers, landscape maintenance professionals, and other Florida citizens how to implement environmentally sound design and maintenance techniques in their landscapes. The principles are outlined briefly here. For more detailed information, please refer to the FFL state office Website (ffl.ifas.ufl.edu) or to *The Florida-Friendly Landscaping™ Handbook for Home Landscapes*.

Principle # 1 Right Plant, Right Place

Plants well-suited to their site need less irrigation and fertilizer and are more resistant to pest infestation. Florida-Friendly Landscaping™ principles encourage the selection of the right plant for the right place, helping you create a healthy, attractive landscape that works with the natural ecosystem rather than against it. Match plants with site conditions based on USDA zone, water and light requirements, soil conditions, salt and wind tolerance, and other factors. The FFL Plant List can help you make the right plant selections for your landscape.

Principle # 2 Water Efficiently

Overwatering not only depletes water supplies, it raises your water bill and makes landscapes more prone to pest infestation. If needed, irrigate plants according to UF/IFAS-recommended rates and application schedules, taking into account local restrictions issued by your water management district. Water only when plants show signs of wilt, preferably in the early morning. Check your irrigation system regularly for leaks and clogs. Do not water if it has rained in the past 24 hours, or if rain is forecast in the next 24 hours. By law you must install, maintain, and operate a device such as a rain sensor that prevents operation of your automatic irrigation system during periods of sufficient moisture.

Principle # 3 Fertilize Appropriately

If fertilization is needed, use UF/IFAS-recommended rates and application schedules to get a healthier lawn and garden. Fertilizing at the correct times and in the correct amounts not only supplies plants with the nutrients they need, it helps prevent fertilizer runoff and leaching that can get into our water supplies and interfere with ecosystem and human health. Fertilizing at the rates recommended by UF scientists helps avoid the excessive growth, pest problems, and higher water requirements that over-fertilization causes.

Principle # 4 Mulch

Florida-Friendly Landscaping™ methods recommend using mulch to protect against soil erosion, maintain soil moisture, inhibit weed growth, improve soil structure and aeration, and reduce pesticide use. The planting beds in a Florida-Friendly landscape will feature one of the types of mulch recommended in *The Florida Yards & Neighborhoods Handbook*.

Principle # 5 Attract Wildlife

Florida-Friendly Landscaping™ encourages Floridians to make their yards attractive to birds, bees, butterflies, bats, and other creatures displaced by rapid urban development. Supply berry bushes, a bird bath, or a bat house; increase vertical layering to provide habitat; manage household pets and reduce insecticide use—all these tricks can welcome wild visitors in need of refuge. Many of these will return the favor by eating pest insects and helping to pollinate your garden!

Principle # 6 Manage Yard Pests Responsibly

The Florida-Friendly Landscaping™ Program advocates a more holistic approach to pest control than merely spraying chemicals. Integrated Pest Management (IPM) creates an effective defense against yard pests while minimizing environmental impact. IPM emphasizes smart planning, proper maintenance, and natural or low-toxicity controls to ensure that plants stay healthy and resist disease and insect infestation. Chemical treatments may still be necessary in some cases, but use of toxic materials will be minimized by this approach.

Principle # 7 Recycle

A Florida-Friendly landscape recycles yard waste generated by activities like mowing, pruning, and raking. Use these leftovers as mulch or compost, returning valuable nutrients to your landscape. Save money and enrich your soil by composting grass clippings, weeds, and plant trimmings and using the compost as an amendment.

Principle # 8 Manage Stormwater Runoff

A Florida-Friendly Landscape uses porous pavers, rain barrels or cisterns, rain gardens, and swales and berms to keep rainwater on site and allow it to percolate into the ground or be captured for later use. Reducing the amount of runoff and the chance for rainwater to wash quickly into storm drains—carrying yard clippings, fertilizer, pesticide, dirt, oil, and other toxins—is the goal of managing stormwater runoff.

Principle # 9 Protect The Waterfront

Implementing Florida-Friendly Landscaping™ design and maintenance methods helps protect water bodies from pollution. If you live on a lake, bay, river, or other water body, keep fertilizers, pesticides, and other toxins away from the water by preserving a 10-foot low-maintenance zone between your landscape and the water. Do not mow, fertilize, or apply pesticides in that area. Even if you do not live immediately on the waterfront, the pesticides and fertilizers you apply in your landscape affect the health of local water bodies through a drainage system called the watershed. The choices you make at home have much farther-reaching consequences than you might imagine.



Designing Your Florida-Friendly Landscape

Florida-Friendly Landscapes are all based on the same nine principles. But Florida-Friendly Landscaping™ encourages individual expression of beauty. As long as you apply the principles described in *The Florida-Friendly Landscaping™ Handbook for Home Landscapes*, your landscape can be Florida-Friendly and as individual as you want.

What if I live in a planned community?

Check with your homeowner association (HOA) before you make changes to your landscape. HOAs usually have a landscape review board and can regulate the appearance and types of plantings in your yard, as long as they do not prohibit you from installing and maintaining Florida-Friendly Landscapes.

If you live in a community with codes, covenants and restrictions that could be more Florida-Friendly, encourage your association to adopt all or part of the model Florida-Friendly Landscaping™ documents, found at www.floridafriendlylandscaping.com.

The Florida-Friendly Landscaping™ Program has a number of “success stories” which highlight water and cost savings for communities that adopt Florida-Friendly Landscaping™ and maintenance practices. Visit the website at www.floridafriendlylandscaping.com.

Design Scenarios

The following eight design scenarios represent select areas of your home landscape—front entry, under windows, utility boxes, etc. Each of these scenarios was chosen because of common landscape design issues that confront a homeowner in these areas.

In each scenario, you will be shown a challenging landscape situation and learn what could be done to design a solution in a more Florida-Friendly manner. Be aware that the graphics show the improved landscapes at an early stage after plant installation. The plants will grow and eventually fill in more of the mulched area.

Scenario A

Two design options - With trees / Without trees



Challenges:

- Not enough plant material in beds
- Plants are not in scale with front of house

Goal:

To create a visually welcoming front entry through the use of color, texture, or fragrance. Be sure to choose plants that are in scale with the size of your lot and house.

Plant Characteristics to Look For:

- Low-growing, compact plants
- Colorful
- Medium or coarse texture
- Bold forms
- Simple growth habit

Design Solutions:

- Place low/small plants next to the walkway to reduce trimming needs
- Place interesting plants at natural view points
- Use small trees to provide a sense of scale and visual interest
- Use colorful or fragrant plants to engage the senses
- Use curved planting beds to draw the viewer's eye through the landscape

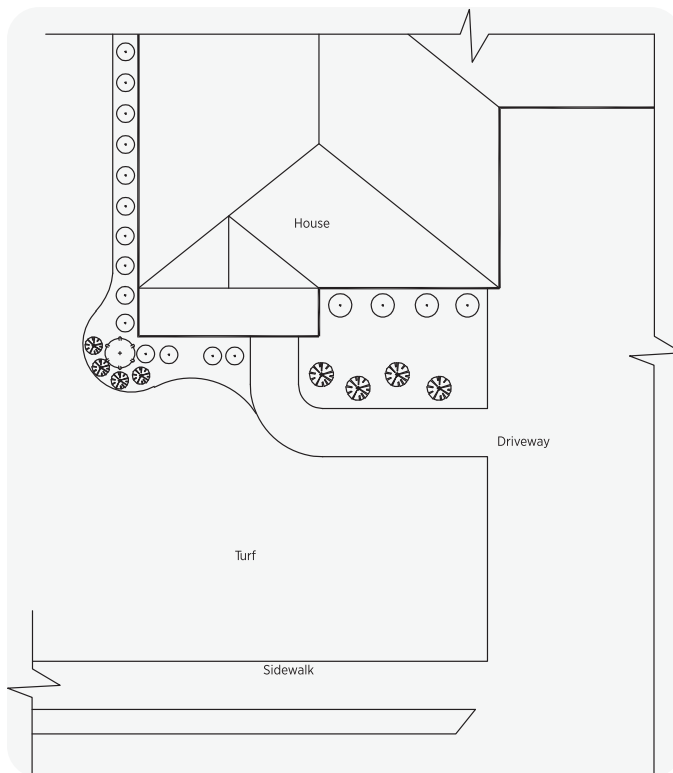

Existing Landscape

Solution 1
With Trees



Solution 2
Without Trees

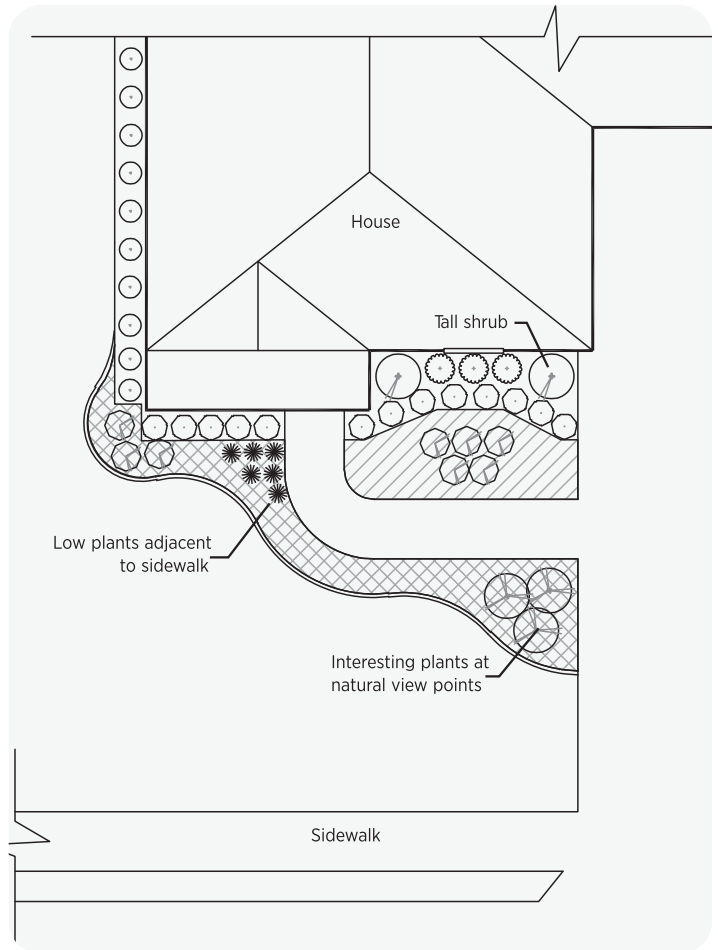
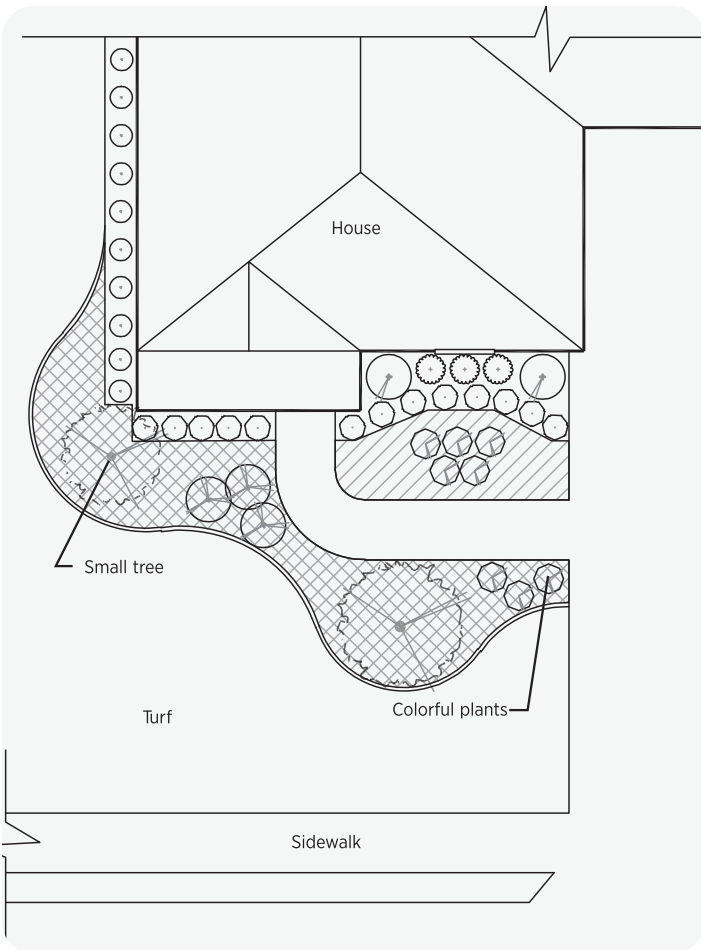

Scenario B: Along Walls

Two design options - With trees / Without trees



Challenges:

- Blank wall is not visually pleasing
- Bare walls act as a heat sink during the summer

Goal:

To break the monotony of blank walls through the use of properly sized foundation plantings. Small trees can be used to provide cooling benefits as well.

Plant Characteristics to Look For:

- Low- or medium-height shrubs
- Soft/fine texture
- Loose foliage
- Flexible branches

Design Solutions:

- Place root ball at least 3' from wall to allow for air flow and maintenance access
- Choose plants with a tidy growth habit and be aware of their mature size to reduce trimming needs
- Choose plants that are color-compatible with the wall
- Consider planting small trees to provide shade and cooling benefits
- Use slightly taller plants between windows to break the monotony of a uniform hedge
- Use shrubs with soft/fine texture and flexible branches for easy pruning and to reduce injury when accessing the wall for maintenance

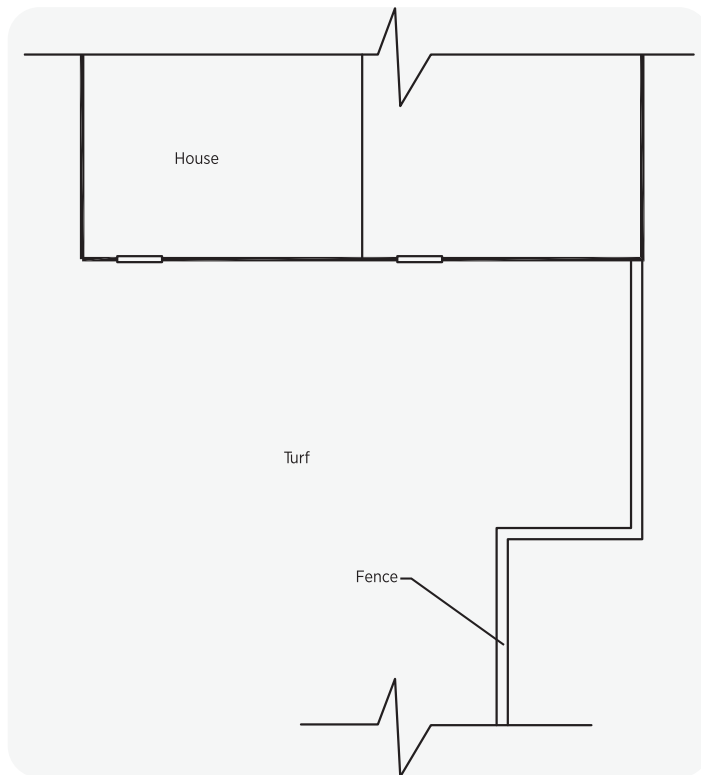

Existing Landscape

Solution 1
With Trees



Solution 2
Without Trees

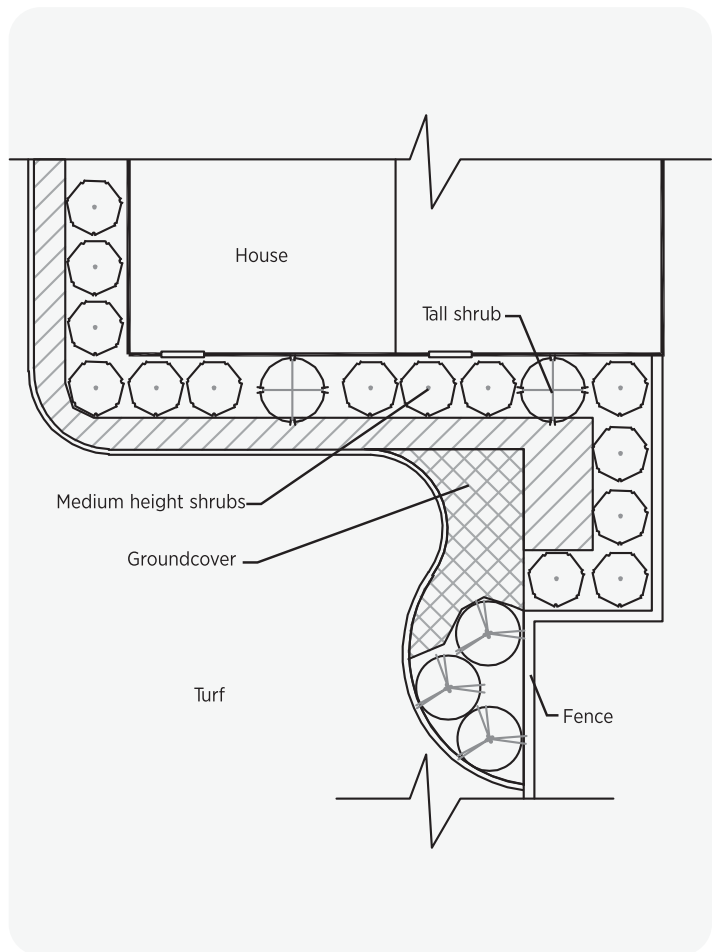
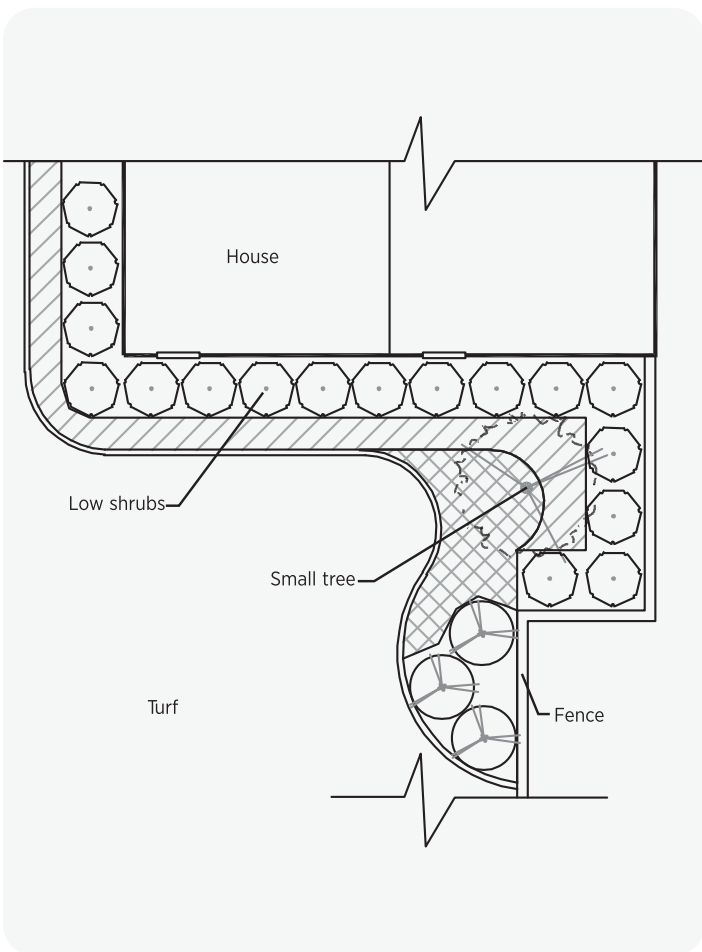

Scenario C: Sidewalks

Two design options - Turf Buffer / Raised Edging



Challenges:

- Turf is in poor condition

Goal:

To reduce trimming and maintenance needs adjacent to the sidewalk. A 4' turf strip or raised edging can be used to keep mulch from washing onto the sidewalk.

Plant Characteristics to Look For:

- Low growing
- Compact growth habit
- Does not attract biting or stinging insects

Design Solutions:

- Reduce trimming and edging needs by placing plants with clean, compact growth habits closest to walkways or by using a turf strip of at least 4' adjacent to the sidewalk
- If a turf strip is not used, consider a raised edging to keep mulch off sidewalks
- Avoid plants that attract biting or stinging insects
- Use plants with interesting textures and colors for close viewing

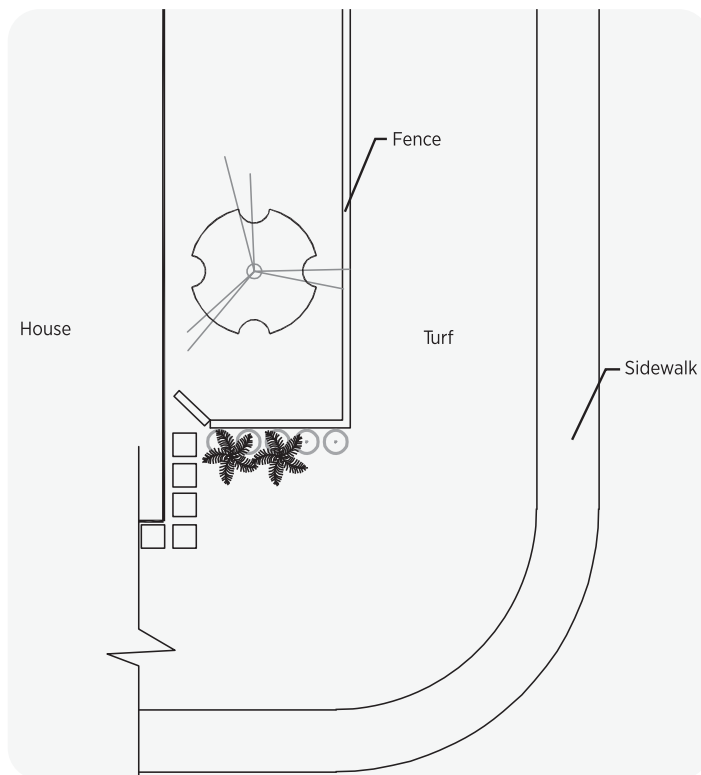

Existing Landscape

Solution 1
Turf Buffer Strip



Solution 2
Raised Edging

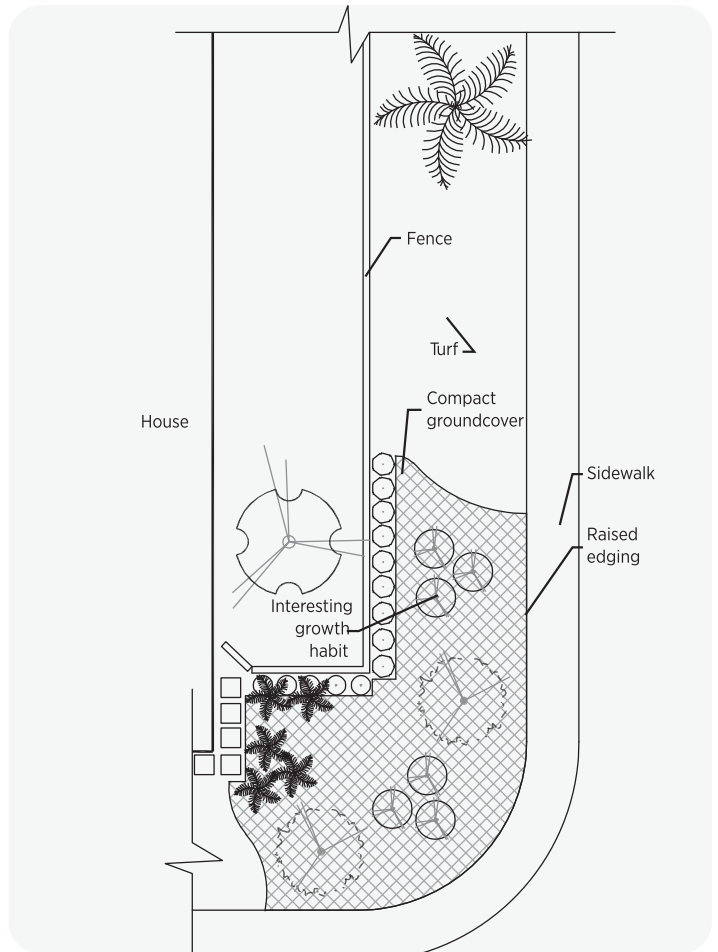
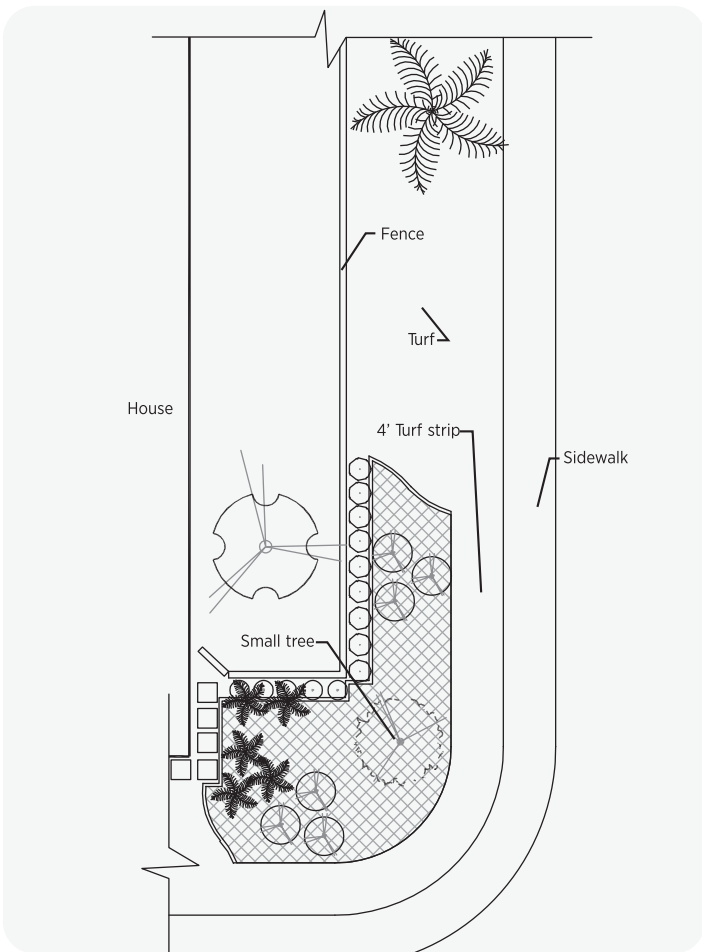

Scenario D: Under Windows

Two design options - No screening / Light screening



Challenges:

- Dense plant blocks rear window
- No plant material around front window

Goal:

To frame windows with plant material to add visual interest and curb appeal. Alternately, plant material can be used to provide light screening of windows to prevent passersby from seeing in through the windows.

Plant Characteristics to Look For:

- Medium height
- No thorns or stiff leaves
- Loose foliage
- Flexible branches

Design Solutions:

- Avoid blocking views by choosing plants with medium height and compact growth habits
- Choose shrubs with a tidy growth habit and allow enough room to access windows for cleaning and hanging storm shutters
- Avoid stiff, thorny plants that would prevent exiting from windows in an emergency situation
- Be aware of the mature size of plants and choose appropriately
- Use small trees with low canopies if shade or screening is desired

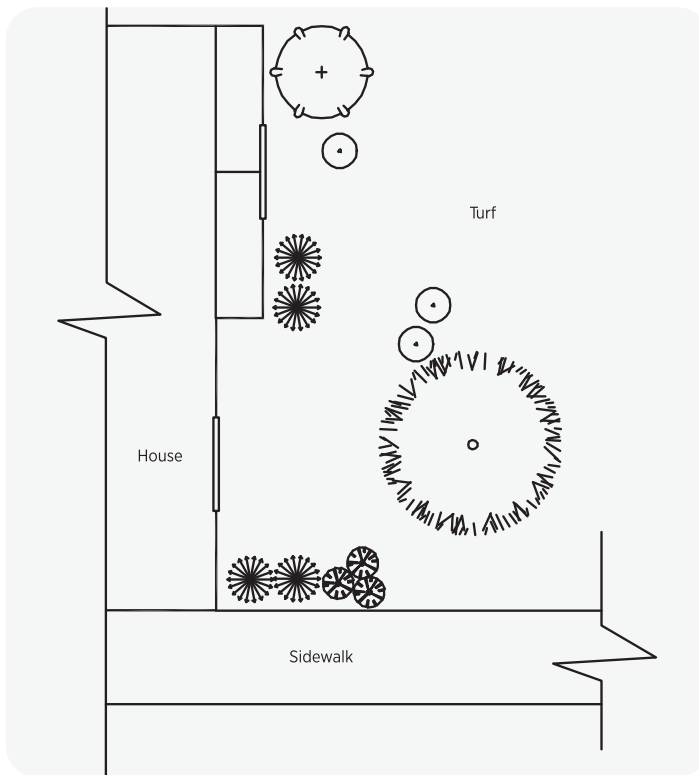

Existing Landscape

Solution 1
No Screening



Solution 2
Light Screening

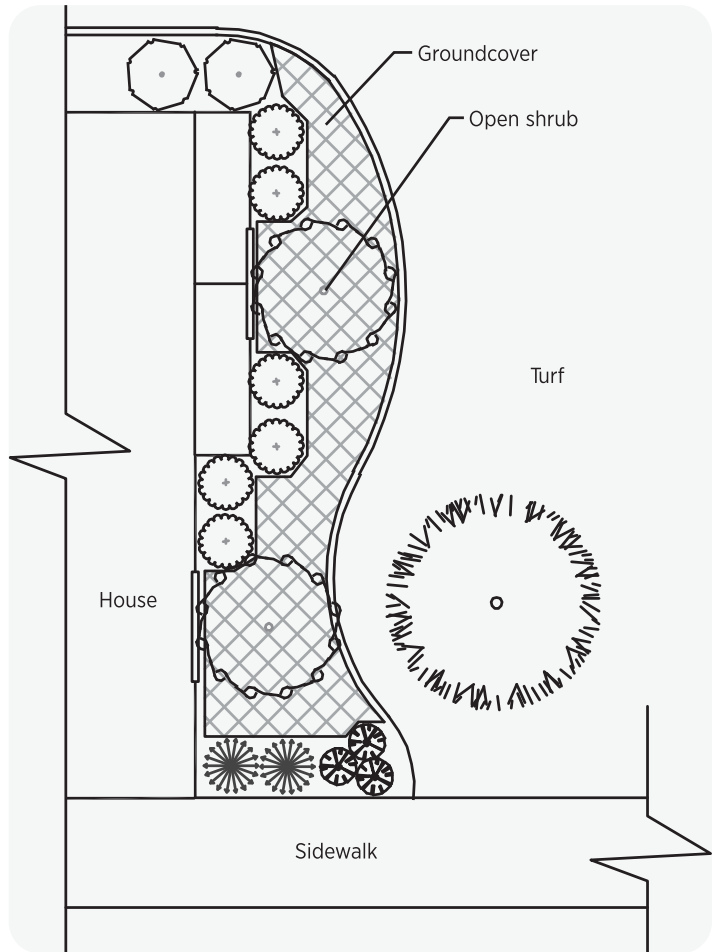
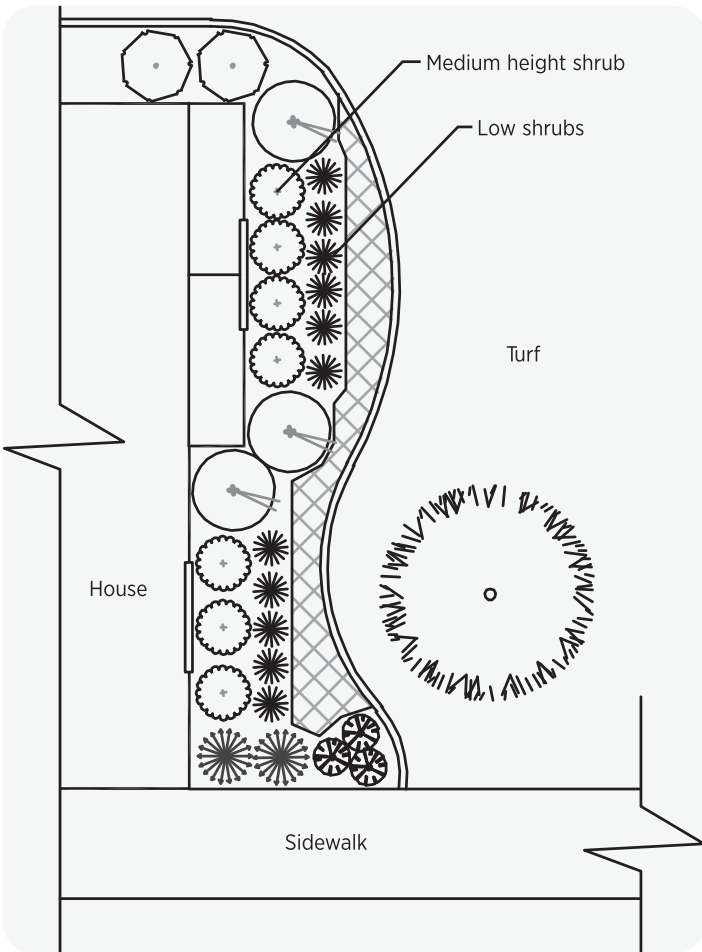

Scenario E: Along Fences

Three design options - Vines / Partial Screening / Full screening



Challenges:

- Bare fence is not visually pleasing
- View from yard needs screening (ex: neighbor's unsightly yard, road, etc.)

Goal:

To turn an unsightly view into a visually pleasing one through the use of colorful vines and evergreen plants. Be sure to choose appropriately sized plants for your design intent.

Plant Characteristics to Look For:

- Dense foliage
- Upright form
- Evergreen
- Fast growing
- Vining

Design Solutions:

- Choose hardy vines with colorful blooms or pleasant fragrance to hide the fence
- Choose fast-growing plants with dense growth habits for screening and privacy
- Select evergreen plants for year-round privacy and color
- Use plants with appropriate height to block unwanted views

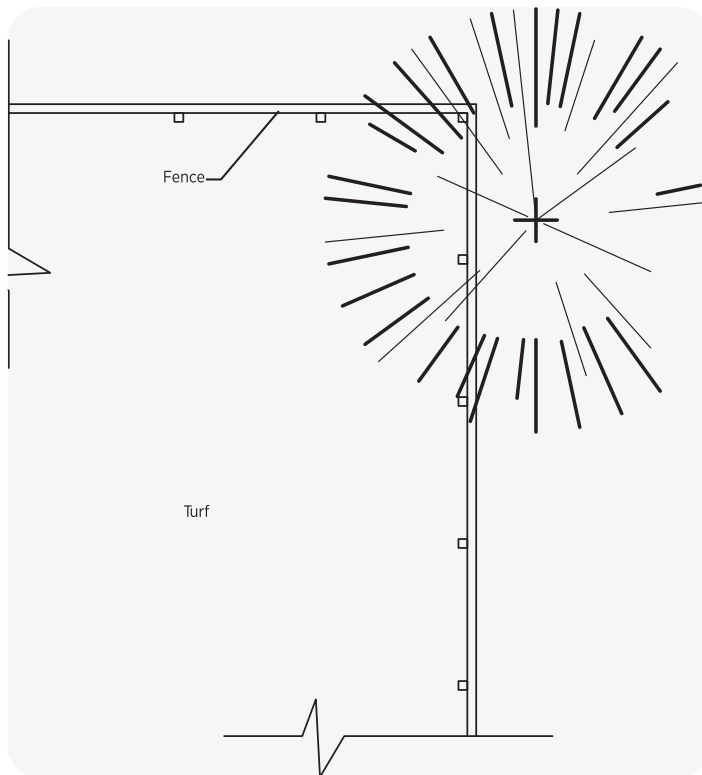

Existing Landscape

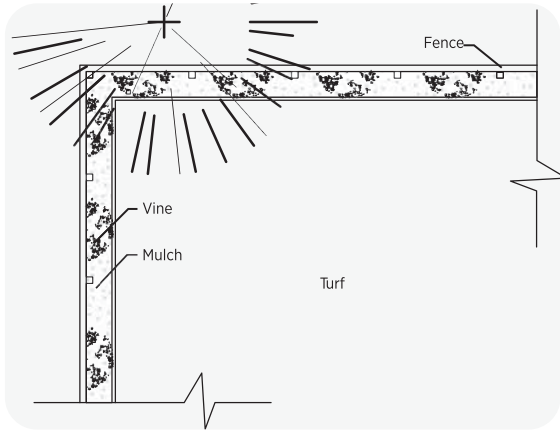

Solution 1
With Vines

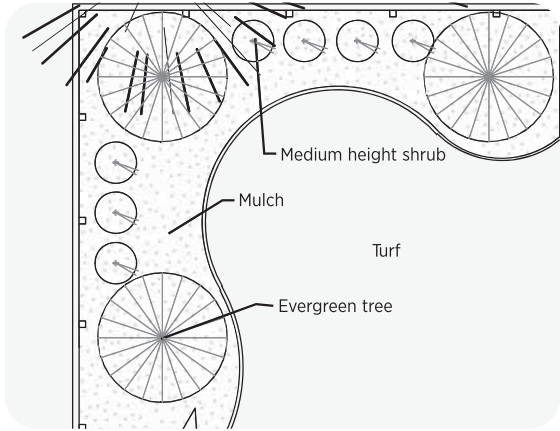

Solution 2
With Partial Screening

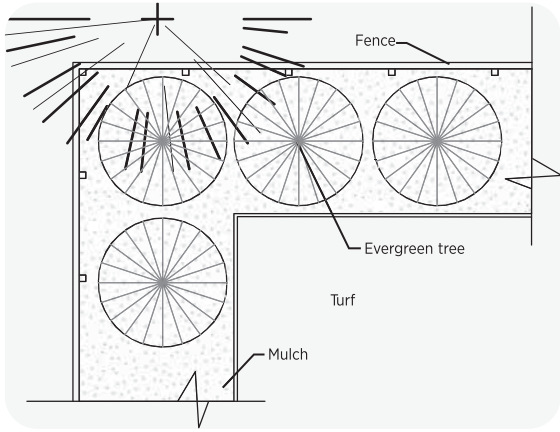

Solution 3
With Full Screening

Scenario F: Under Trees

Two design options - Open canopy / Dense shade



Challenges:

- Turf is in poor condition
- Plants are too close to trunk
- Mulch area is too small

Goal:

To turn an unsightly view into a visually pleasing one through the use of colorful vines and ever-green plants. Be sure to choose appropriately sized plants for your design intent.

Plant Characteristics to Look For:

- Shade tolerant
- Shallow roots
- Groundcover with spreading growth habit

Design Solutions:

- Use plants that look good alongside fallen leaves
- Install small plants to avoid root damage to the tree
- In dense shade where plant options are limited, consider allowing fallen leaves to create a self-mulching bed

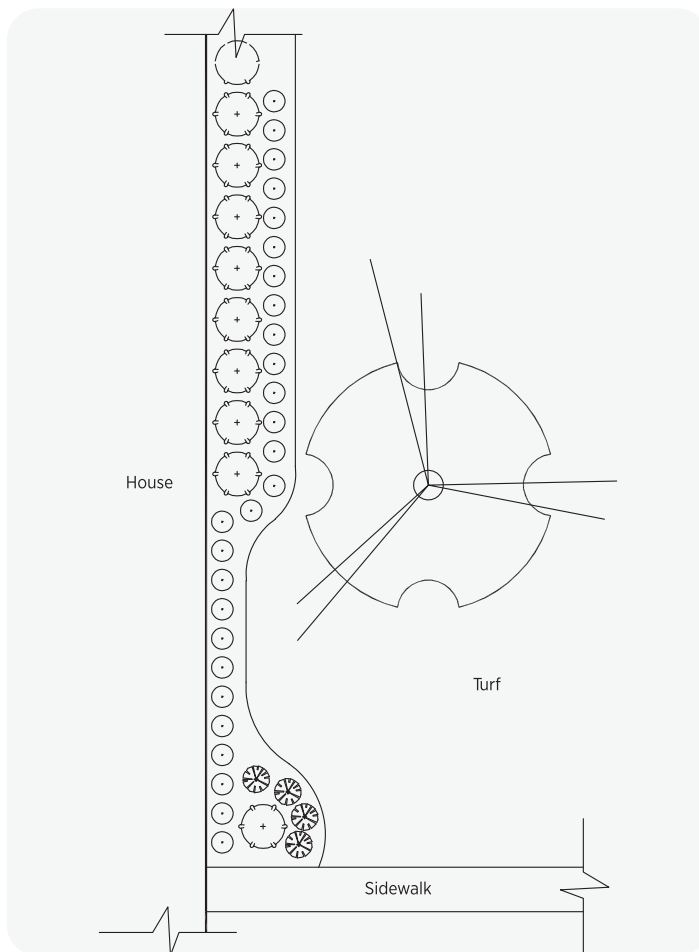

Existing Landscape

Solution 1
Open Canopy



Solution 2
Dense Shade

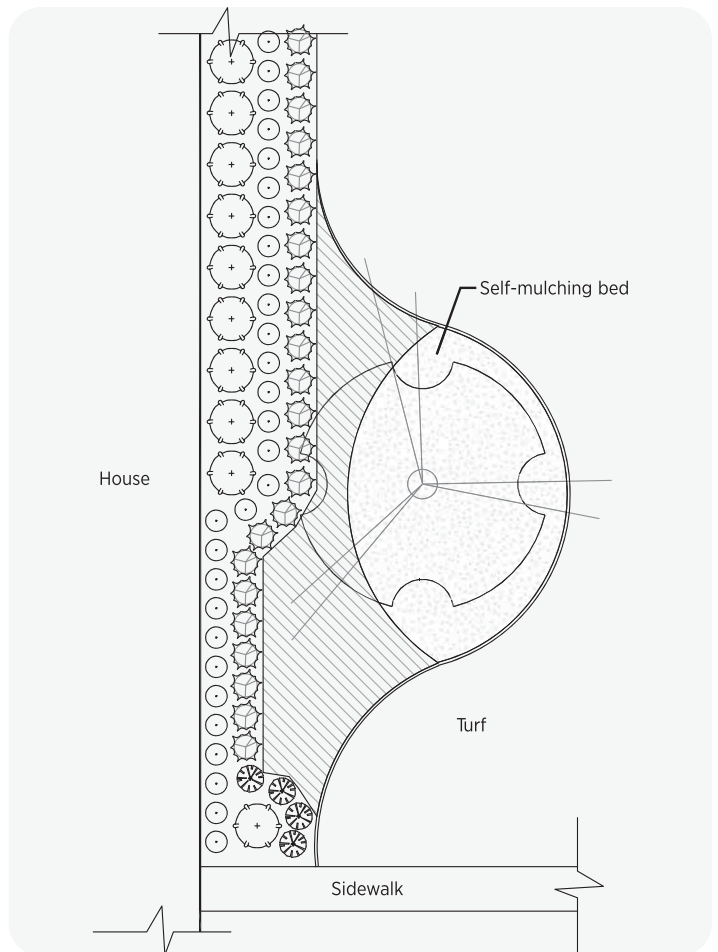
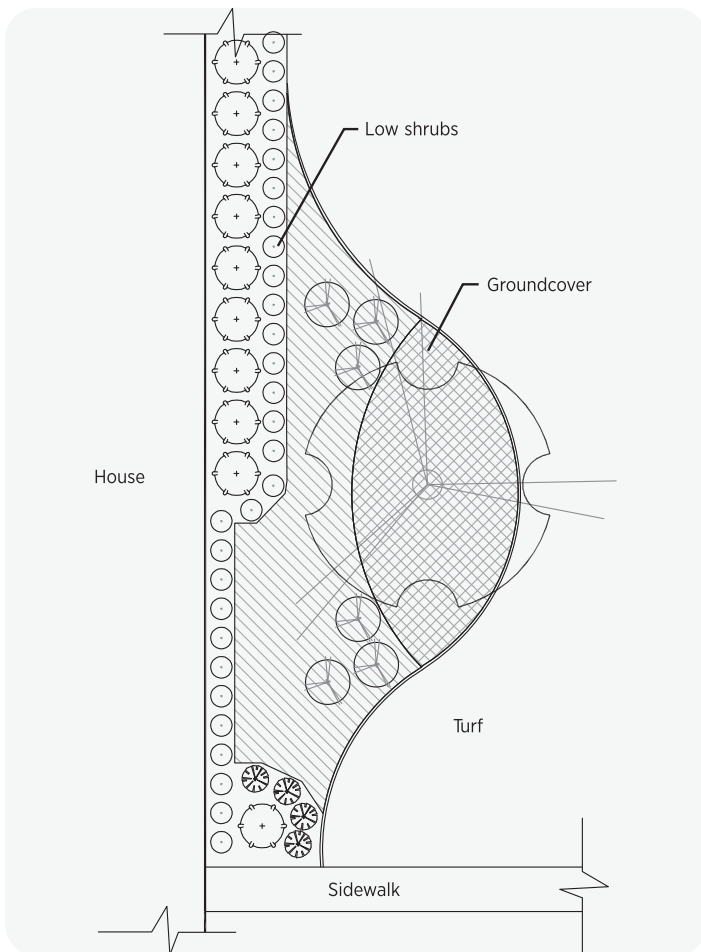

Scenario G: Utilities

Two design options - Full blend / Partial blend



Challenges:

- Utility box is not visually pleasing

Goal:

To create a plant bed around an unsightly utility to make it blend into the landscape. Be sure to allow room to access the utility when the need arises.

Plant Characteristics to Look For:

- Low/medium shrubs
- Simple growth habit
- Soft foliage
- No flowers/bees
- No thorns

Design Solutions:

- Consult with your local utility company for planting regulations around utilities
- Use plants with soft foliage so the branches can be bent back to allow for access
- Don't try to hide the utility but rather try to make it blend in with the plant bed
- Consider the mail carrier and meter reader when selecting plants, avoid plants that attract stinging insects and plants with thorns

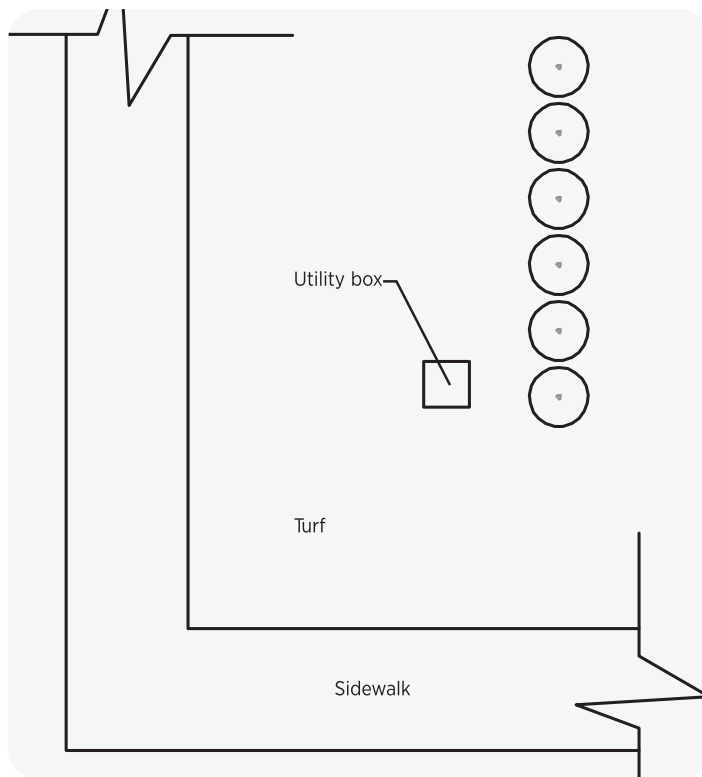

Existing Landscape

Solution 1
Full blend



Solution 2
Partial Blend

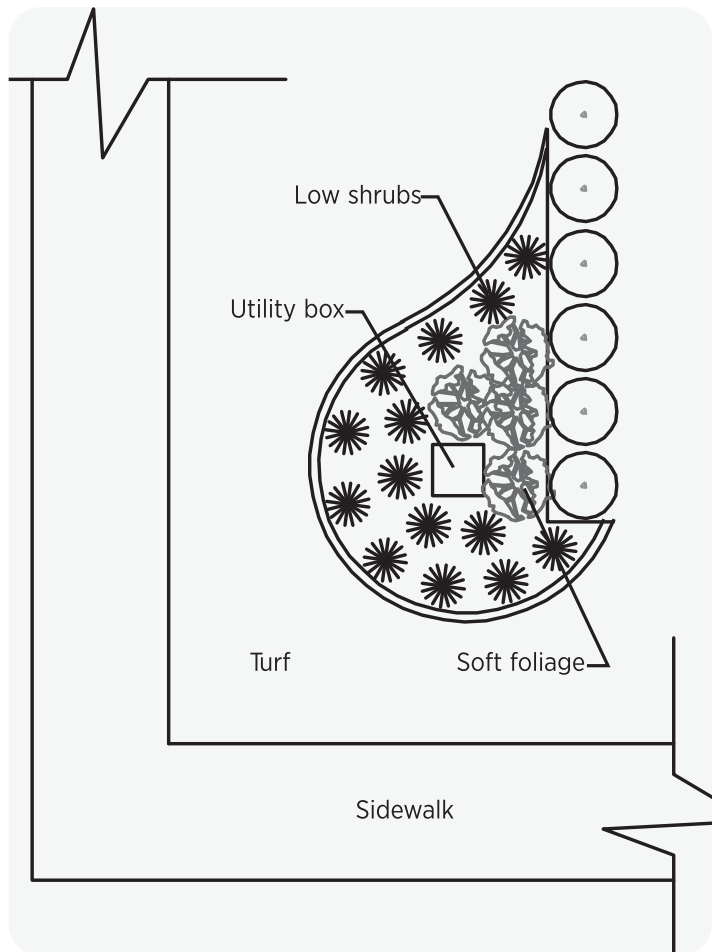
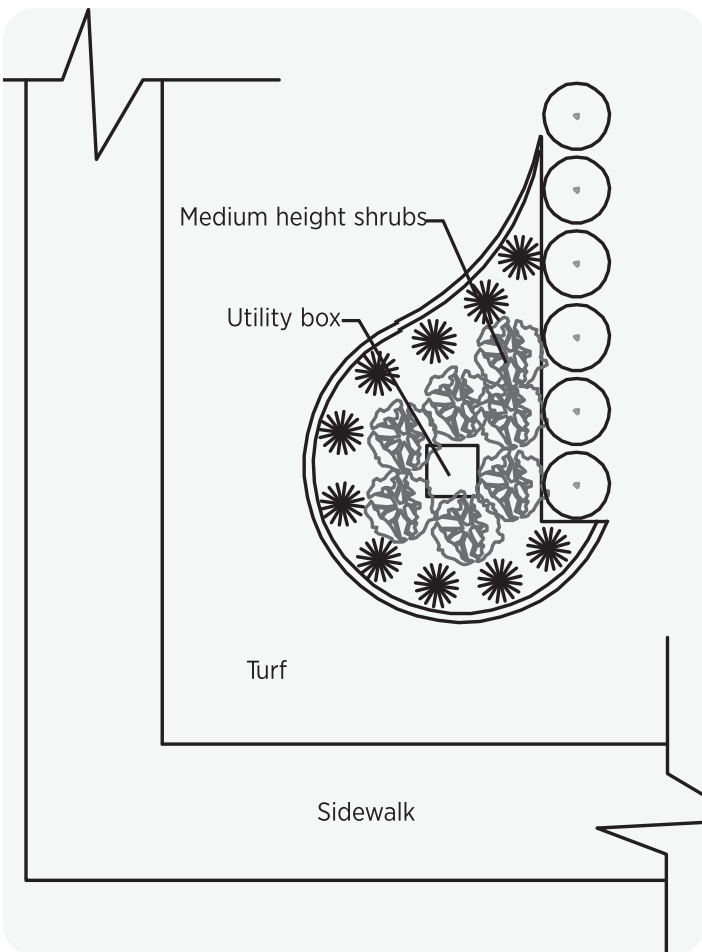

Scenario H: Standing Water

One design option - Rain garden



Challenges:

- Water is slow to drain and collects in low areas
- Compacted soil

Goal:

To turn low wet areas into rain gardens that will collect and filter rain water. Rain gardens can be attractive features in dry times as well, if appropriate plant and material selections are made.

Plant Characteristics to Look For:

- Ability to survive prolonged wet conditions
- Also able to tolerate dry conditions (when water is absent)

Design Solutions:

- Consider having the low area(s) excavated by a professional and use the excess soil to create berms around the rain garden
- Use plants that will survive wet (or dry) conditions for long periods of time
- Line the bottom of the rain garden with rocks and boulders to provide visual interest during dry periods

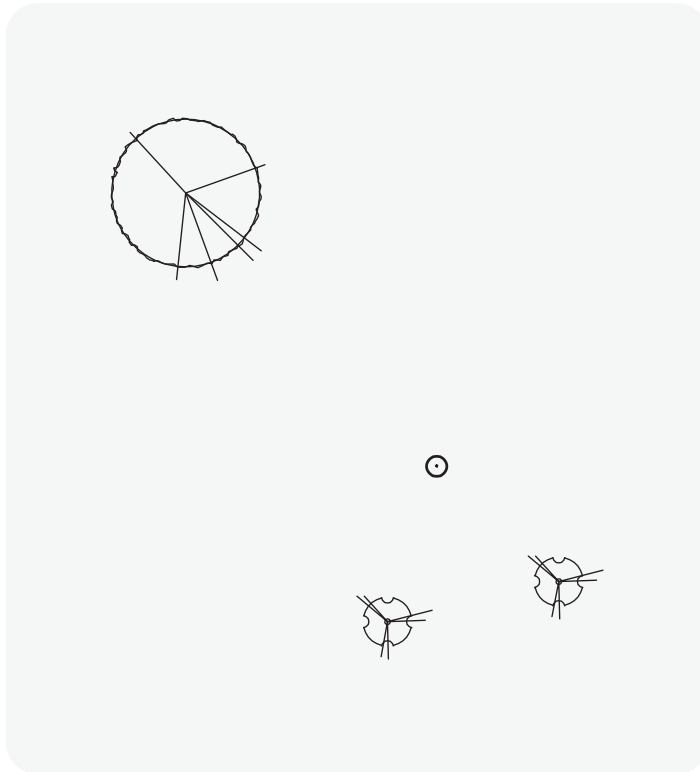

Existing Landscape

Solution
Rain Garden

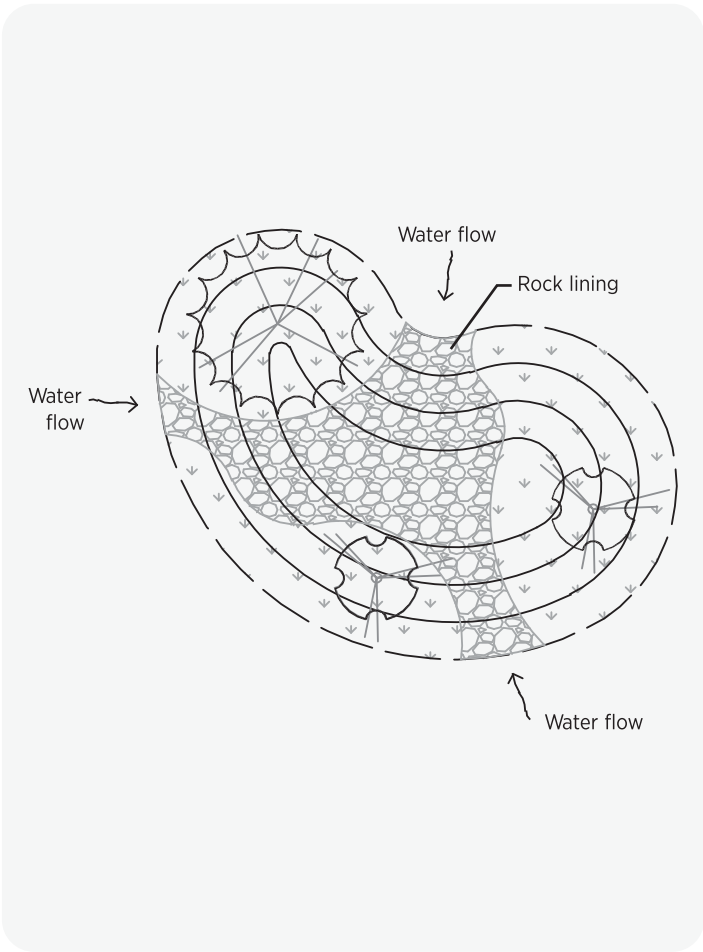

Converting Your Yard to a Florida-Friendly Landscape

A Florida-Friendly Landscape is ecologically sound and cost effective. If you get the chance to design a landscape from scratch, you can go Florida-Friendly all at once. But sometimes it is not practical for a homeowner with an established landscape to make the changeover to a Florida-Friendly design immediately. Converting an established yard to a Florida-Friendly Landscape can be done most effectively in about three years and seven steps.

Overview of the Step-By-Step

First, develop a master plan on paper. Second, install any patios, walkways, or decks (hardscapes). Heavy equipment and materials used in the construction of hardscapes should be used before planting to avoid crushing the plants. Third, prepare areas to plant trees. Trees should be planted before other plants because they require more time to reach a size that will provide shade and mulch (leaf litter). The final steps in the conversion involve working in small sections and installing plant beds and mulch in phases.

The Florida-Friendly Master Plan

Whether you are designing a landscape from scratch or converting to a Florida-Friendly Landscape, create a Florida-Friendly Master Landscape Plan. This is a complete plan for your yard that includes all elements in precise locations and takes into account the nine Florida-Friendly Landscaping™ principles. To create the master plan, you may find it helpful to use the Landscape Planning Worksheet provided in this guide or a similar form. Conduct a site inventory and analysis to determine the opportunities and constraints of your yard. Pay attention to soil type, existing vegetation, shade patterns, drainage patterns, views, and utility locations. Homeowners should also consider their needs and wants.

Draw the master plan to scale, including property boundaries from a certified survey, the location of the house and any existing hardscape, and the location of any trees or plants to remain on site. Complete the master plan by adding all proposed plants, hardscapes, and specified construction materials. If applicable, check with your HOA before beginning the design process, and be sure to obtain final approval from the responsible committee. Use the nine FFL principles, design elements, and fundamentals of design described in this guide to create outdoor “rooms” by using pathways, hardscapes, and plants to divide and organize spaces. Also consider the following:

- Proportion: Keep the size of the plants proportional to the house and yard.
- Variety: Make the yard interesting by having variation in plant sizes (especially heights), color, texture, and shape.
- Composition: Group and arrange plants in overlapping masses based on the size, form, color, and growing requirements.
- Emphasis: Use dramatically different plants as focal points to attract attention.

The Seven Steps

The seven-steps described below illustrate the phased process of converting a landscape, including the addition of new hardscape, trees, and Florida-Friendly plant material to a typical development landscape. If all steps are followed, the final product will be a Florida-Friendly Landscape created over a three-year period.

1 -Develop a Master Plan

Include some of the following elements in your Florida-Friendly Master Landscape Plan:

- Turf areas, plant beds, and mulch areas
- Entertainment and circulation areas such as pathways, decks, and patios
- Trees and shrubs (placed for energy efficiency and as screens/buffers for views)
- Plantings to screen A/C units & utilities
- Concealed work/trash area
- Wildlife habitat plantings
- Garden shed/compost bin
- Cisterns/rain barrels (located by downspouts)
- Rainwater collection areas (low spots or rain gardens)

2 -Install hardscapes (Patios, walkways,decks pools etc.)

Call before you dig. State law requires that you call the free Utility Locator Service at 811 at least two full business days before you dig. www.callsunshine.com

- Install all new hardscapes at the same time to save money by not destroying plants later.
- Use porous pavers, concrete or gravel, to allow stormwater drainage.
- Use durable materials and, whenever possible, use reclaimed, reprocessed, or recycled-content materials (EDIS pub 1110/EP374).
- Minimize the movement of trucks and equipment in the yard to avoid soil compaction.
- If using underground irrigation, install the system before installing plants.

3 -Create New Tree Beds

- Mark the edge of the new tree bed with a rope.
- Remove sod or other plant material and till to aerate soil in tree bed area.
- Put down a 2-3"-thick layer of Florida-Friendly mulch to protect the soil.

4 -Install Trees

- Choose healthy trees appropriate for your climate and conditions (wind, moisture, soil, etc.), and use proper installation techniques (<http://hort.ifas.ufl.edu/woody/planting.shtml>).
- Wind proof by grouping trees together and locate to provide selective shade. Call to locate underground utility lines before digging.
- Install any new trees located near proposed hardscape after the hardscape is installed (Step 2).

5 -Prepare (Phase I) Plant Beds

- Consult the master plan to decide where to install the first planted area. Your choice will be determined by your needs.
- Remember to leave clear access to the backyard if you do the front yard first.
- Use boundaries such as walkways, fences, or house corners to determine the extent of the planted area.

6 -Install (Phase I) Plant Beds

- Relocate existing plants as indicated on the master plan and space relocated and new plants accordingly.
- Use proper installation practices for planting.
- If you are not installing the plants, hire landscape contractors certified in Florida-Friendly Green Industry Best Management Practices (GI-BMPs).
- Mulch newly installed plants to control weeds and reduce runoff (EDIS pub FOR80/FRO79).
- Follow a UF/IFAS-recommended irrigation schedule until plants are established (EDIS pub ENH857/EP113) and then reduce irrigation as needed.

7 -Repeat Steps 5&6 for additional phases of plant beds

Additional phases of plant beds are determined by your needs. For Phase II, you may choose to plant the area that is contiguous to the Phase I plants, or you may decide to plant another area of the garden that is used often or for a different purpose.

Follow the procedures used in Phase I to prepare beds and install the Phase II plants. If a temporary irrigation system was used in Phase I, the system can be relocated to use in Phase II.

Remember the plants in Phase II will initially be smaller than the plants in Phase I, but they will quickly catch up and fill in the space.

You may want to choose less visible areas for the last phase(s). Again, follow the procedure used in previous phases I and II to prepare and install additional beds.

Remember the plants in later phases will be smaller than the plants in the earlier phases, but they will also quickly catch up. Maintain the yard with Florida-Friendly Landscaping™ principles described in *The Florida-Friendly Landscaping™ Handbook for Home Landscapes* and in this publication. If you are not maintaining the landscape, hire a landscape contractor who is certified in the GI-BMPs.

Ecological Considerations

Florida-Friendly Landscape design combines art and science to create functional, attractive, and ecologically sound surroundings that complement a home or other structure. But Florida-Friendly Landscaping™ guidelines need not restrict your choices of color, texture, and style. Here are some tips to bear in mind when planning your landscape.

Form Follows Function

Landscape designers often recommend grouping plants into masses to unify the design of plant beds. Groups of plants are visually pleasing, and this technique also provides environmental benefits. Trees planted in groups provide more atmospheric cooling than the same number of evenly spaced, isolated trees and are much better protected in high winds. In addition, trees planted in combination with appropriate shrubs and groundcovers form effective windbreaks and wildlife habitat.

Plant Matchmaking

Turfgrasses and landscape plants have different water, fertilizer, and maintenance needs. Group plants in beds according to water requirements to conserve water and make maintenance easier.

Wet Versus Dry

Many drought-tolerant plants thrive in elevated dry spots or in windy areas but can quickly succumb to root diseases and pest problems if planted in areas that tend to stay wet. Drought-tolerant plants do well in exposed areas and along the unshaded southern or western walls of buildings, but you should place plants adapted to wet soils in low spots, along waterways, and in areas with poor drainage.

Wind-Wise Plantings

Florida winter winds tend to blow from the north or northwest. A solid fence or a row of evergreens on the north side of a house forms a barrier against cold winter winds, which can dry and damage plants. In the summer, winds typically originate in the south, so allow cooling breezes in your outdoor living spaces by keeping tall barriers away from the southern edge of your landscape. Since Florida is frequently in the path of hurricanes, choose trees that are known for sturdiness in high winds.

Made in the Shade

Position trees and shrubs strategically to help cool or heat your home. Plant deciduous shade trees on the south, east, and west sides of a house to cast shade in summer and allow warming in winter. Tree shade can significantly reduce air conditioning

costs. An air-conditioning system's outdoor compressor/condenser unit uses less energy when it is shaded from direct sun during the day, but be careful not to block the unit's airflow. If the warm discharge air cannot escape, the intake air temperature rises, causing the unit to operate less efficiently.

The Lowdown on Turfgrass

Healthy lawns cool and clean the air by absorbing carbon dioxide, releasing oxygen, and collecting dust and dirt. They filter stormwater runoff and reduce erosion, glare, and noise. But the many benefits of grass are only realized when it's cared for and used properly. Grass thrives in sunny areas, but most types do not grow well in dense shade. In shady spots, plant shade-tolerant groundcovers instead of turf.

Natives Versus Non-Natives

A common misconception is that Florida-Friendly Landscaping™ principles dictate the use of only plant species native to Florida. In fact, the FFL Program encourages a mix of natives and non-natives, depending on what plants are right for that particular location. "Right Plant, Right Place" governs the selection of plants, bearing in mind the soil, light, water, wind, and other conditions at that site. Do not forget to consider plant colors, textures, and bloom times. See the IFAS Assessment of Non-native Plants in Florida's Natural Areas (<http://assessment.ifas.ufl.edu/>) for a list of invasive species that should be removed where possible and never planted.

Soil Conditions

It is important to know your soil type before selecting plants for the site. Your landscape may have different soil types in different areas. A soil test can tell you the pH of your soil and what amendments may be used, such as compost or manure, to improve or alter your soil conditions. If your soil is compacted, as is frequently the case on new home sites, you should loosen and amend your soil as you add planting beds for optimum root health.

Plant Selection

The choice of plants determines how much maintenance a landscape requires and also how long it lasts. Use these steps as a guide to selecting the right plants for the right places in your Florida-Friendly yard.

- Choose low-maintenance plants suited to your site.
- Welcome wildlife.
- Group high-maintenance plants together for greater visual impact and easier care.

- Eliminate invasive plants.
- Buy quality plants.
- Consider the mature size of the plant.
- Avoid monocultures and aim for a mosaic of trees, shrubs, grasses, and groundcovers.
- Plan turf areas to be functional and low-maintenance.
- Use groundcovers on slopes where grass is difficult to maintain.
- Choose slow-growing plants that will last longer and create less work.
- Consider wind tolerance.
- Think of maintenance requirements.

Plant Sorting

If you are renovating your landscape, it is wise to keep some of the plants you already have. Follow these simple guidelines to sift through your botanical choices.

- Keep healthy plants.
- Discard tightly spaced plants.
- Retain trees with long life spans.
- Save clusters of trees and the plants growing beneath them.
- Remove unsuitable plants.
- Relocate plantings out from under eaves.

Choosing a Landscape Maintenance Service

If you lack the desire or ability to do your own landscape work, you may decide to hire a professional maintenance company. Look for companies whose employees have obtained a certificate of completion in the Florida-Friendly Best Management Practices for Protection of Water Resources by the Green Industries (GI-BMPs). These professionals will know how to care for your landscape in a Florida-Friendly manner. All commercial fertilizer applicators must have this certificate of completion and the accompanying license from the Department of Agriculture and Consumer Services (FDACS). Check out hirefloridafriendly.com for more information.

Landscape Planning Worksheet

This worksheet can be used for both new & established landscapes. By following these steps, you will be on your way to a thriving, low-maintenance landscape suited to your climate and needs.

1. Decide why you want to landscape.

Most homeowners think of landscaping as a way to add beauty to their home or to improve their property's resale value. Other reasons to landscape are more specific, such as enhancing or screening a view, creating a microclimate, or attracting wildlife. You may need a play area for your children, or perhaps you would like to entertain family and friends outdoors. Your passion may be raising vegetables or simply savoring a lovely view.

Before you begin, think about how you will use your landscape. Write down as many ideas as possible. It is much easier to remove elements from your plan than it is to add them down the line.

2. Obtain a soil analysis.

Soil plays a big part in any landscape project, influencing what plants will thrive in your yard. Determine your soil's texture (sandy to clay), and have it tested to determine the pH—the level of acidity or alkalinity. This information will help you decide which plants are best suited to the conditions of your yard.

Soil texture: _____

pH: _____

Any exceptions? (For example, the place where you want to put a planting bed may have more acidic soil than other areas in the landscape.)

3. Draw a site plan.

You can use a pencil, ruler and graph paper, or computer software to draw your site plan. Do not worry about getting the scale just right. If you have a survey of your property, you can copy it and draw on the copies.

Draw your house and existing trees, shrubs, and other plants you want to keep. If you already have an irrigation system, be sure to note its location and various zones. Include permanent features such as utilities, hardscapes like the driveway, and water sources like spigots. See the sample site plan provided for guidance.

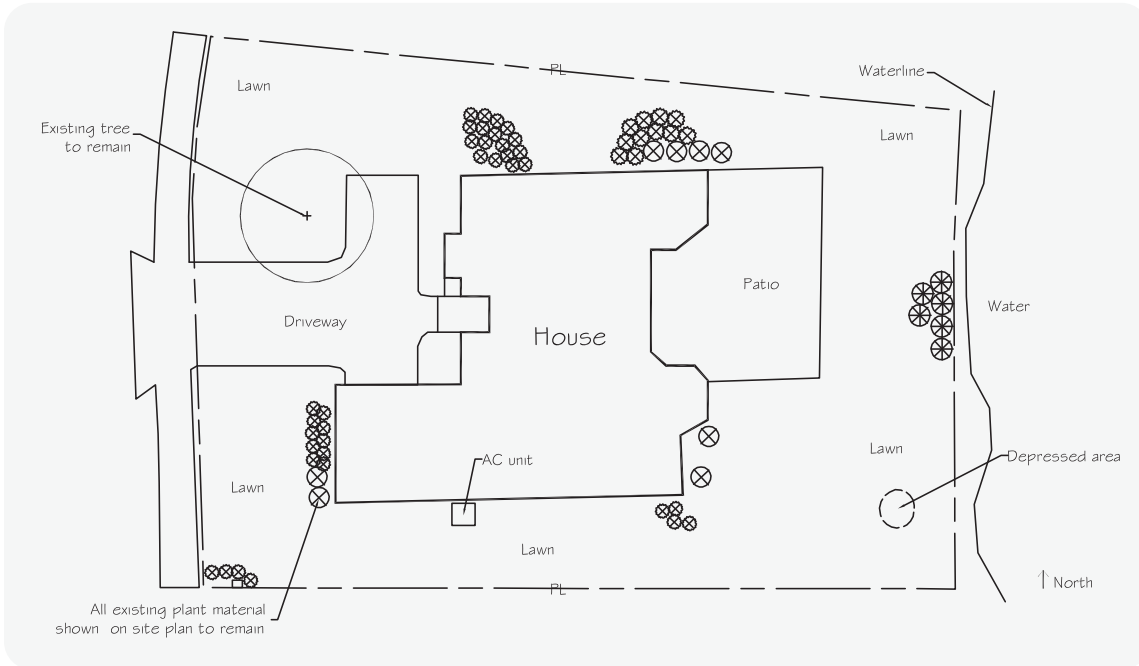

4. Inventory your landscape.

Walk around your property with your site plan, noting conditions and features that make your yard unique. Does your site call for plants that are tolerant of cold, wind, full sun, shade, drought, occasional flooding, or salt spray? Be sure to make note of any particularly good views that could be enhanced or bad views that need to be screened. See the sample site inventory & analysis provided for guidance.

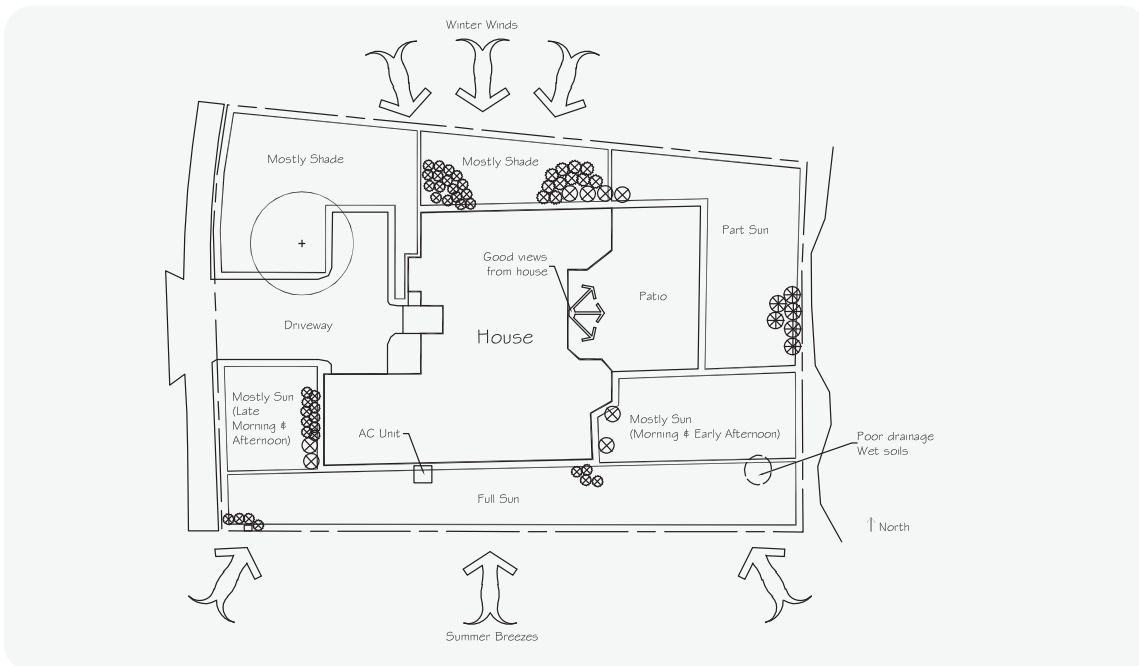

What kinds of conditions does your landscape have?

5. Draw an activity diagram.

On a clean copy of your site plan, sketch the locations where activities will take place (refer to your answers for step 1). Make sure to consider views. Is there a spot you regularly look at that you want to enhance with plants that attract birds or butterflies? Are there structures or equipment, such as a utility box or shed, which you would like to hide? See the sample activity diagram provided for guidance.

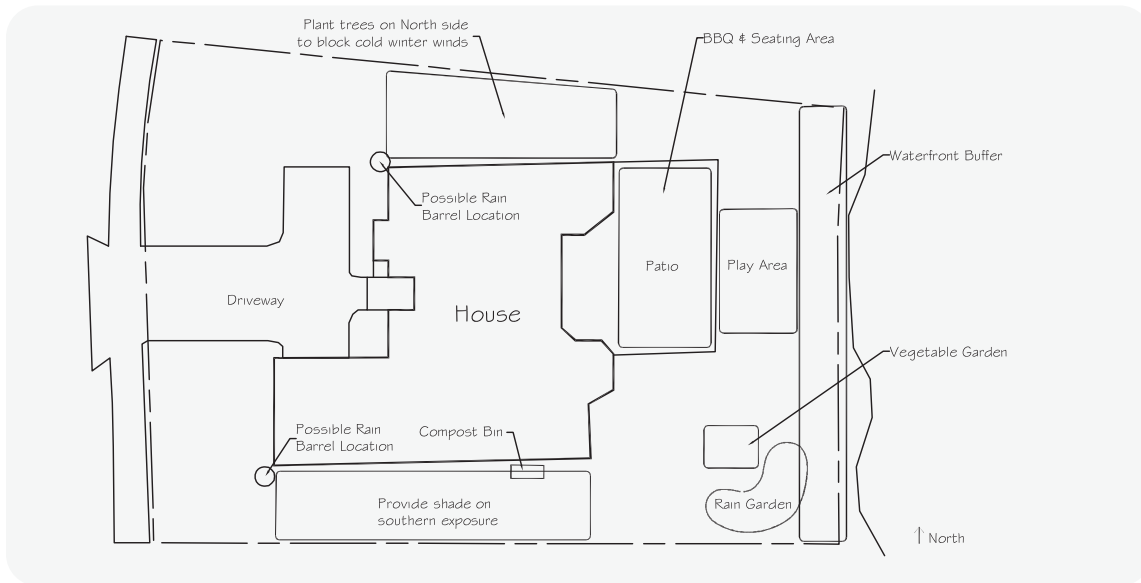

6. Create a landscape plan.

Your landscape plan will be guided by the site inventory and analysis and activity maps discussed in steps 4 and 5. Based on these other two diagrams, determine the types of plants you want in different locations. Do not worry about choosing specific plants yet—just identify where you want trees, shrubs, groundcovers, flowering plants, and grass areas. See the sample landscape plan provided in the next section for guidance.

THE FLORIDA-FRIENDLY LANDSCAPE MASTER PLAN.

Now that you have a plan, you can choose plants suited for the conditions in your landscape using the Florida-Friendly Landscaping™ Plant List beginning on page 42.

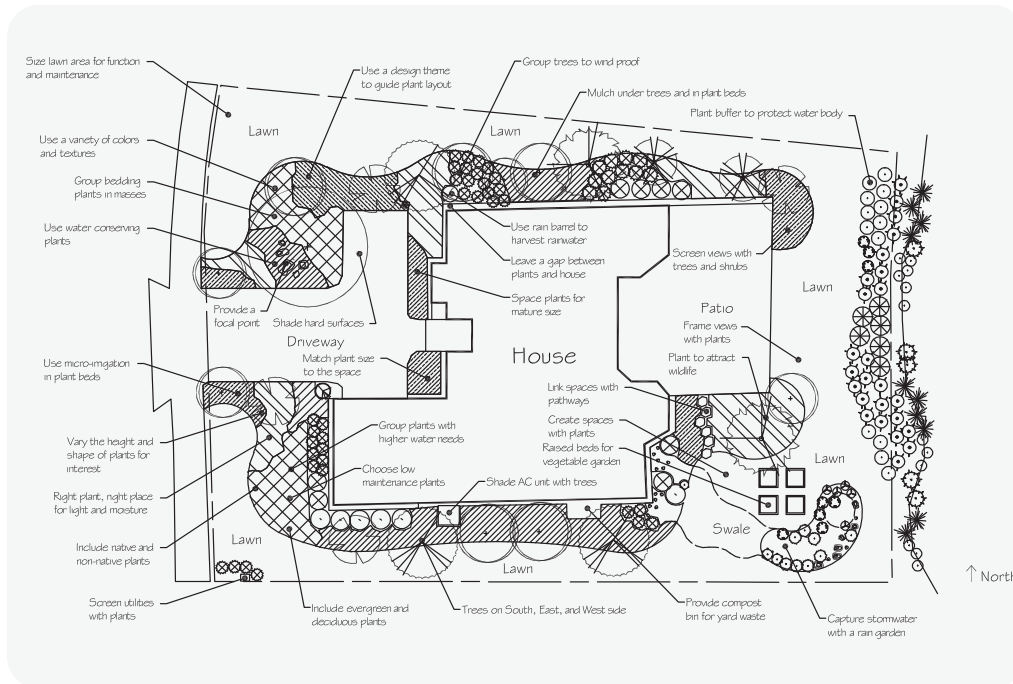

Five Common Gardening Mistakes

Avoid these five common mistakes for a more Florida-Friendly Landscape.

1- Overwatering: Watering to the point of runoff or leaching

Problem:

Creates pest and disease problems, wastes water, and can wash pollutants into water bodies.

Solution:

Do not water if it has rained in the past 24 hours, or if rain is forecast in the next 24 hours. Check your irrigation system regularly, make sure you apply only moderate amounts of water, and ensure that your rainfall shutoff device is working.

2- Overplanting: Designing a landscape with more plants that can be adequately Sustained

Problem:

Can result in cramped plants more prone to disease. Crowded plantings can also interfere with sidewalk and driveway access and block views from windows.

Solution:

Design landscapes with the plants' mature sizes in mind. If landscapes must look "full" quickly, use plants that are already at mature or nearly mature size.

3- Overpruning: Removing more foliage or branches from a plant than is healthy for it.

Problem:

Can weaken trees and shrubs, making them more susceptible to insect or disease problems.

Solution:

Never remove more than 30 percent of the foliage from an ornamental plant or shrub at one time. Know the right time of year to prune your plant, and use plants that are the right size for the location.

4- Fertilizing inappropriately: Applying more fertilizer than necessary, applying the wrong kind of fertilizer, or applying it at the wrong time of year

Problem:

Can cause pollution if washed into ground or surface water, causing fish kills and unhealthy algal blooms. Can also burn plant roots.

Solution:

Fertilize only when needed, using a fertilizer containing slow-release nitrogen. For turf, do not exceed the rate of 1 lb. total N per 1,000 sq. ft. of lawn at each application. Use compost and other soil amendments to supply plant nutrients instead of fertilizing. "Weed and feed" products are not recommended.

5- Using pesticides incorrectly: Applying more than the recommended amount of pesticides, applying the wrong pesticides or applying them too often.

Problem:

Can cause insects to develop resistance to the chemicals and may harm beneficial garden insects.

Solution:

Use Integrated Pest Management (IPM) for an environmentally friendly approach to pest management. Avoid overwatering and fertilizing inappropriately to help keep pests from becoming a problem.



Florida-Friendly Landscaping™ Plant List

The plants on this Florida-Friendly Plant List are considered by UF/IFAS horticulture specialists to be well adapted to growing in Florida landscapes. The plants on this list are not the only plants that can be used in Florida. Contact your county's UF/IFAS Extension office to determine if a plant not on the list is suitable for your region.

When planted under appropriate soil, light, and climatic conditions, most plants on the list generally require little maintenance compared with other plants. Each plant's preferred growing conditions (soil pH, soil texture, relative drought tolerance, soil drainage/moisture, light range, light optimum, and salt tolerance) are included here as a guide to choosing plants for your specific site conditions. Additional information is given on growth rate, mature height and spread, flowering color and season, value to wildlife, wind resistance and other characteristics helpful for plant selection and maintenance.

Many plants listed as Annuals are considered Perennials in some areas of the state and vice versa. The microclimate and the amount of care given to the plants will ultimately determine their staying power in the landscape.

See the key to symbols and abbreviations used in the tables for details. Remember to always put the right plant in the right place by matching each plant's needs with the environmental conditions found at the site. There may be variation in some characteristics, especially in the region (north, central or south) of Florida in which plants will grow. Check with your county's UF/IFAS Extension office to confirm the appropriateness of specific plants (look in the government pages of your phone book or see <http://solutionsforyourlife.ufl>).

Use the list to choose plants based on your site conditions, following these tips.

1. Find out and write down the conditions of the bed or other area you want to plant: The region of the state you live in. (Check the map on page 41 and remember that if you live close to the border of a region, all of the plants listed for that region may not do well in your area and some of the plants that do well in the next region may do well in your area.)

The amount of light the site receives (Check at various times throughout the day and through the seasons.)

Soil pH and texture. The pH ranges given in the legend are not absolute, but rather for guidance as to the optimum pH conditions. Some plants may do well if the pH is slightly higher or lower than those listed (Take samples and obtain a soil test through your county's Extension office.)

Soil moisture (Is it in a high, dry area or a low area where water frequently accumulates? To check drainage, dig a small hole, add water and see how quickly the water drains – if water stands for more than 24 hours, consider it a wet site.)

Exposure to salt spray or salty irrigation water.
Size of area for plants. (Are there height restrictions such as a window nearby or power lines above? Is the width of the area limited?)

2. Determine the type of plant you want (tree, shrub, etc.) and go to that category on the list.

3. Narrow down the list by choosing plants that match the region, light, soil conditions and moisture at the site.

4. Further narrow your list to those plants that will fit the site based on mature height and spread.

5. Consider the need for salt tolerant plants, if applicable, and any additional factors you are interested in, such as wildlife value or flower color and season.

For further assistance, contact the Florida-Friendly Landscaping™ Program or horticulture program at your county's UF/IFAS Extension office.

This list is meant as a guide to start choosing plants appropriate for your conditions. The absence of a plant from this list does not imply that it is not well adapted to Florida landscape conditions. This list will be updated periodically. Please check with your county's UF/IFAS Extension office for future updates. For additional information and fact sheets on many of the plants on this list, see also edis.ifas.ufl.edu/.

Key to Symbols and Abbreviations

Florida Region Zones

Region (includes Florida regions in which plant will grow):

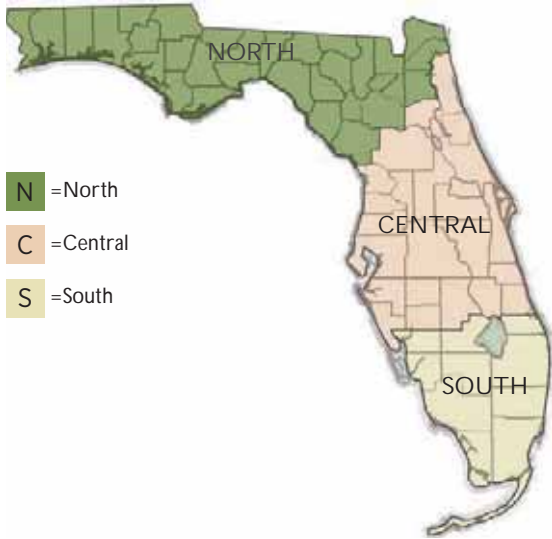

- N =North
- C =Central
- S =South

USA Cold Hardiness Zones

Includes Florida zones only.

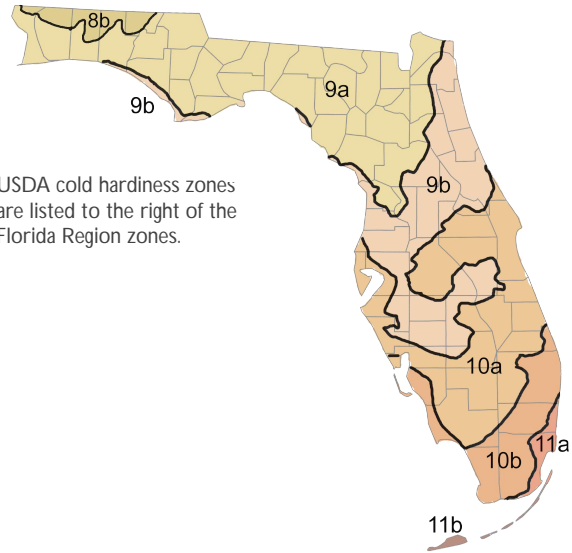

USDA cold hardiness zones are listed to the right of the Florida Region zones.

Native Status

Yes = Florida native No = Not a Florida native Var. = Native status depends on species selection

GROWTH RATE, HEIGHT AND SPREAD:

Growth rate = Slow or Fast (if no rate is given the plant does not grow exceptionally fast or slow.)

↑ = mature height in feet ⇔ = mature spread in feet

Soil pH (Gives the Range Tolerated By the Plant):

- = Acid 4.5-5.5
- = Acid to slightly acid 4.5-6.5
- = Acid to slightly alkaline 4.5-7.2
- = Slightly acid 6.0-6.8
- = Slightly acid to slightly alkaline 6.0-7.2
- = Slightly acid to alkaline 6.0-8.0
- = Tolerates any soil pH 4.5-8.0

Soil Texture:

C/L = clay loam S/L = sandy loam S = sandy S/C = sandy clay any = any texture

SOIL MOISTURE:

- ☾ = well drained
- ☾ = medium drained
- = wet
- ☾● = well drained to medium drained
- ☾●● = medium drained to wet
- ☾●●● = well drained to wet

Drought Tolerance:

High, Medium, Low, or None

(Note: Both drought tolerance and soil moisture tolerance should be considered, and they are not the same. For example, a plant may tolerate wet soils and also have high drought tolerance, and another plant may prefer well drained soils but have low drought tolerance.)

Light Range and Light Optimum:

- ☀ = Full Sun
- ☁ = Partial Shade
- ☁ = Shade
- = Optimum light conditions

Salt Tolerance:

H = High M = Medium L-N = Low to None U = Unknown

Wildlife:

- 🦋 = Attracts butterflies
- 🐦 = Attracts hummingbirds
- 🐦 = Attracts other birds

Large Trees

Scientific Common
Reg/Native
G, H, S
Soil pH, Txt
Soil Mst, Drgt
Light/Best Salt
Wildlife



<i>Acer barbatum</i> Florida Maple, Southern Sugar Maple	
N	8b-9a Yes
25-60↑	25-40⇒
●●○○	Any
☾☾	High
☀☁☁	L-N
also known as <i>Acer saccharum</i> ssp. <i>floridanum</i> ; green, spring flowers; susceptible to aphids and cottony maple scale	



<i>Acer rubrum</i> Red Maple	
N C S	8-10 Yes
Fast	35-80↑ 25-35⇒
●●○○	Any
☾☾	Medium
☀☁☁	L-N
red, winter through spring flowers; red fall foliage; susceptible to aphids, cottony maple scale, and gall mites; shallow-rooted; does best in rich, organic soils; good for wet sites; medium to low wind resistance	



<i>Betula nigra</i> River Birch	
N C	8-9a Yes
	40-50↑ 25-35⇒
○○●○	Any
☾☾	Low
☀☁☁	L-N
needs soil space for root expansion; grows best with high soil moisture; chlorosis develops in alkaline soil; tolerates periodic flooding but not long periods of drought; medium to high wind resistance	



<i>Bucida buceras</i> Black Olive, Oxhorn Bucida, Gregorywood	
S	10b-11 No
Fast	45-60↑ 35-50⇒
○○●●	Any
☾	High
☀☁☁	H
white, spring flowers; messy fruit and leaves; medium-low wind resistance; susceptible to pests; caution - may be invasive in South Florida	



<i>Carya</i> spp. Hickories, Pecan	
N C	8b-9a Yes
50-100↑	25-70⇒
●●○○	Any
☾☾	High
☀☁☁	L-N
edible fruit (<i>C. illinoensis</i>); white/yellow, spring flowers; high wind resistance for <i>C. floridana</i> , medium to high for <i>C. glabra</i> and <i>C. tomentosa</i> , low for <i>C. illinoensis</i> ; susceptible to pests	



<i>Chorisia speciosa</i> Floss-silk Tree	
C S	9b-11 No
Fast	35-50↑ 40-55⇒
●●●●	Any
☾☾	High
☀☁	L-N
rapid grower first few years; deciduous, pink/white, five-petaled fall through winter flowers; large roots form base just beneath soil	



<i>Conocarpus erectus</i> Buttonwood, Silver Buttonwood	
S	10b-11 Yes
	5-50↑ 15-20⇒
○○●●	Any
☾	High
☀☁☁	H
white/cream, spring flowers; susceptible to pests; high wind resistance; provides cover and nesting for wildlife	

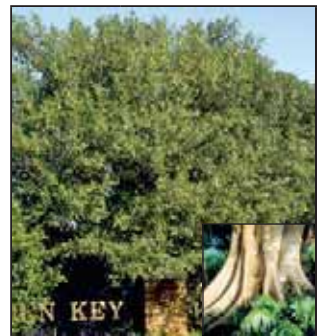

<i>Ficus aurea</i> Strangler Fig	
S	10b-11 Yes
Fast	40-60↑ 30-50⇒
●●●●	Any
☾	High
☀☁☁	M
not for small areas; spreading canopy shades parks, large yards; may start as epiphyte, killing host tree (often encircling cabbage palm); fallen fruits may be messy; medium-low wind resistance, can be difficult to distinguish from invasive species; susceptible to pests	

Scientific Common
Reg/Native
G, H, S
Soil pH, Txt
Soil Mst, Drgt
Light/Best Salt
Wildlife



<i>Fraxinus americana</i> White Ash
N 8 Yes
50-80↑ 50-80⇒
●●○○○ Any
☾☾ Medium
☀ ☁☁ L-N
🦋 🐦
tolerates occasionally wet soil; does not tolerate compacted soil; susceptible to ash borer, cankers, and leaf spots; medium-high wind resistance



<i>Fraxinus caroliniana</i> Pop Ash, Carolina Ash, Water Ash
N C 8-9 Yes
30-50↑ 20-35⇒
●●○○○ Any
☾☾ Medium
☀ ☁☁ L-N
🦋 🐦
good plant for retention ponds, swales and canal banks; does best in rich, organic soils



<i>Fraxinus pennsylvanica</i> Green Ash
N C 8-9 Yes
50-100↑ 30-70⇒
●●○○○ Any
☾☾ Medium
☀ ☁☁ ☁ L-N
🦋
good for shaded areas; medium to low wind resistance; susceptible to pests; does best in rich, organic soils

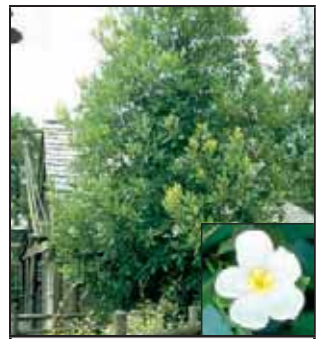

<i>Gordonia lasianthus</i> Loblolly Bay
N C 8-9 Yes
Slow 30-60↑ 20-30⇒
●●○○○ C/L
☾☾ Low
☀ ☁☁ L-N
white, spring through summer flowers; good for retention pond edges; can tolerate full sun only with sufficient moisture; does best in rich, organic soils; susceptible to nematodes

Scientific Common
Reg/Native
G, H, S
Soil pH, Txt
Soil Mst, Drgt
Light/Best Salt
Wildlife



<i>Gymnanthes lucida</i> Crabwood
S 10b-11b Yes
Slow 15-30↑
○○●●● Any
☾ High
☀ ☁☁ M
small shade tree; compact growth habit- can be planted in between buildings



<i>Halesia carolina</i> Carolina Silverbell
N 8 Yes
20-40↑ 15-30⇒
●●○○○ Any
☾☾ Medium
☀ ☁☁ L-N
showy, white, spring flowers; yellow fall foliage with attractive yellow fruit; understory tree that does best in rich, organic soil; water during drought and avoid compacted soils



<i>Juniperus virginiana</i> Red Cedar
N C 8-9 Yes
Fast 40-50↑ 10-25⇒
●●○○○ Any
☾ High
☀ ☁☁ H
🦋 🐦
very similar to <i>Juniperus silicicola</i> but branches straighter; provides food for wildlife



<i>Liquidambar styraciflua</i> Sweetgum
N C 8-9 Yes
40-100↑ 40-60⇒
●●●●○ Any
☾☾ Medium
☀ ☁☁ M
🐦
many cultivars; provides food for wildlife; medium to high wind resistance

Large Trees

Scientific Common
Reg/Native
G, H, S
Soil pH, Txt
Soil Mst, Drgt
Light/Best Salt
Wildlife



<i>Liriodendron tulipifera</i> Tulip Poplar, Tulip Tree, Yellow Poplar	
N	8-9a Yes
80-100↑	40-80⇒
●●●○	Any
☾	Medium
☀ ☁	L-N
🦋	
yellow/orange, spring through summer flowers; susceptible pests and diseases; newly transplanted trees susceptible to leaf yellowing and drop w/o enough moisture; low wind resistance	



<i>Litchi chinensis</i> Lychee	
S	10a-11 No
Fast	20-30↑ 20-30⇒
●●●○	Any
☾ ☾	Medium
☀ ☁	L-N
small, yellow, early spring flowers; edible fruit in June and July; susceptible to scales	



<i>Lysiloma latisiliquum</i> Wild Tamarind, Bahama Lysiloma	
S	10b-11 Yes
Fast	40-60↑ 30-45⇒
○●●●	Any
☾	High
☀ ☁	H
🦋 🐦	
small, white/pink, spring through summer flowers; medium to high wind resistance	



<i>Magnolia grandiflora</i> and cvs. Southern Magnolia	
N C	8-9 Yes
40-80↑	15-40⇒
●●●○	Any
☾ ☾	Medium
☀ ☁	H
🐦	
white/cream, fragrant, summer flowers; attractive red seeds provide food for wildlife; tolerates occasionally wet soil; high wind resistance; leaves and fruit require frequent cleanup; attractive pyramidal growth habit; susceptible to scale	



<i>Magnolia virginiana</i> and cvs. Sweet Bay Magnolia	
N C	8-9 Yes
40-60↑	20-50⇒
●●●○	Any
☾ ☾	None
☀ ☁	L-N
🦋 🐦	
white, spring flowers; small red seeds provide food for wildlife; medium-high wind resistance	



<i>Nyssa sylvatica</i> Tupelo, Black Gum	
N	8b-9a Yes
Slow	65-75↑ 25-35⇒
●●●○	Any
☾ ☾ ☾	High
☀ ☁	M
🐦	
showy fall color; white, inconspicuous spring flowers; medium to high wind resistance	



<i>Persea americana</i> Avocado	
C S	9b-11 No
Fast	35-40↑ 25-35⇒
●●●○	Any
☾	Medium
☀ ☁	L-N
🐦	
many cultivars for edible fruit; low wind resistance; susceptible to pests	



<i>Pinus clausa</i> Sand Pine	
N C S	8-10b Yes
Slow	25-40↑ 15-25⇒
●●●○	Any
☾	High
☀ ☁ ☁	H
🦋 🐦	
flammable - in wildfire prone areas, plant minimum 30' from buildings; trunk is rarely straight; makes a nice accent in a large scale landscape; seeds provide food for wildlife	

Scientific Common
Reg/Native
G, H, S
Soil pH, Txt
Soil Mst, Drgt
Light/Best Salt
Wildlife

Scientific Common
Reg/Native
G, H, S
Soil pH, Txt
Soil Mst, Drgt
Light/Best Salt
Wildlife



<i>Pinus elliottii</i> var. <i>densa</i> Southern Slash Pine
C S 9-11 Yes
Fast 75-100↑ 35-50⇒
●●○○○ Any
High
H
Wildlife
flammable - in wildfire prone areas, plant minimum 30' from buildings; medium to low wind resistance; seeds provide food for wildlife; tolerates occasionally wet soil; declines if roots and surrounding areas are compacted or disturbed; susceptible to pests



<i>Pinus elliottii</i> var. <i>elliottii</i> Northern Slash Pine
N C 8-9 Yes
Fast 75-100↑ 35-50⇒
●●○○○ Any
High
H
Wildlife
flammable - in wildfire prone areas, plant minimum 30' from buildings; medium to low wind resistance; seeds provide food for wildlife; tolerates occasionally wet soil; declines if roots and surrounding areas are compacted or disturbed; susceptible to pests



<i>Pinus glabra</i> Spruce Pine
N 8-9a Yes
Slow 30-60↑ 25-40⇒
●●○○○ Any
Medium
L-N
Wildlife
flammable - in wildfire prone areas, plant minimum 30' from buildings; low wind resistance; declines if roots and surrounding areas are compacted or disturbed



<i>Pinus palustris</i> Longleaf Pine
N C 8-9 Yes
60-80↑ 30-40⇒
●●○○○ Any
High
L-N
Wildlife
flammable - in wildfire prone areas, plant minimum 30' from buildings; medium to low wind resistance; susceptible to pests; resistant to fusiform rust; tolerates occasionally wet soil

Scientific Common
Reg/Native
G, H, S
Soil pH, Txt
Soil Mst, Drgt
Light/Best Salt
Wildlife



<i>Pinus taeda</i> Loblolly Pine
N C 8-9b Yes
Fast 50-80↑ 30-35⇒
●●○○○ Any
Medium
M
Wildlife
flammable - in wildfire prone areas, plant minimum 30' from buildings; fast growing; 3-6" cones; susceptible to pests and diseases



<i>Piscidia piscipula</i> Jamaican Dogwood, Fish Poison Tree
S 11 Yes
Fast 30-50↑ 30-50⇒
●●●●○ Any
High
H
Wildlife
deciduous; lavender/white flowers; all parts are poisonous; provides food for wildlife



<i>Platanus occidentalis</i> Sycamore, American Planetree
N C 8b-9a Yes
Fast 75-90↑ 50-70⇒
●●○○○ Any
Medium
M
Wildlife
needs space; sheds continually; leaves scorch if insufficient water; susceptible to mites, lace bugs, and anthracnose; good for erosion control on stream banks; medium to low wind resistance



<i>Quercus acutissima</i> Sawtooth Oak
N 8-9a No
40-50↑ 50-70⇒
●●○○○ Any
High
M
Wildlife
provides food for wildlife; tolerates occasionally wet soil

Large Trees

Scientific Common
Reg/Native
G, H, S
Soil pH, Txt
Soil Mst, Drgt
Light/Best Salt
Wildlife



Quercus alba
White Oak

<input checked="" type="checkbox"/> N	<input checked="" type="checkbox"/> C	8-9	Yes
Slow	60-100↑	60-80⇒	
●●○○	Any		
☾☾	Medium		
☀☁	H		
🦋	🐦		

provides food for wildlife; not adapted to dry areas; does best in rich, organic soil; medium to high wind resistance



Quercus austrina
Bluff Oak

<input checked="" type="checkbox"/> N	<input checked="" type="checkbox"/> C	8-9	No
	40-60↑	35-50⇒	
●●●○	Any		
☾☾	High		
☀	L-N		
	🐦		

provides food for wildlife; underused tree that is well adapted to Florida



Quercus falcata
Southern Red Oak,
Spanish Oak, Turkey Oak

<input checked="" type="checkbox"/> N	<input checked="" type="checkbox"/> C	8-9a	Yes
	60-80↑	60-70⇒	
●●●○	Any		
☾	High		
☀	M		
🦋	🐦		

low wind resistance; provides food for wildlife



Quercus macrocarpa
Bur Oak

<input checked="" type="checkbox"/> N		3a-8b	No
	70-90↑	60-80⇒	
●●●●	Any		
☾☾☾	High		
☀	H		

trees are well-suited for street, park and parking lot planting but enough soil space should be available to accommodate growth



Quercus michauxii
Swamp Chestnut Oak

<input checked="" type="checkbox"/> N	<input checked="" type="checkbox"/> C	8-9	Yes
	50-60↑	40-60⇒	
●●○○	C/L		
☾☾	Low		
☀☁	L-N		
	🐦		

provides food for wildlife; tolerates occasionally wet soils; in wet soils rot may be a problem; best in full sun but tolerates shade when young; tolerant of urban conditions; medium to high wind resistance; may slow growth of under-story plants



Quercus muehlenbergii
Chinkapin Oak

<input checked="" type="checkbox"/> N		3a-8b	Yes
Fast	40-60↑	50-60⇒	
●●●●	Any		
☾☾	High		
☀	M		



Quercus nuttallii
Nuttall Oak

<input checked="" type="checkbox"/> N		8	No
	60-80↑	35-50⇒	
●●○○	Any		
☾☾	Medium		
☀	L-N		
	🐦		

provides food for wildlife; tolerates occasionally wet soil



Quercus shumardii
Shumard Oak

<input checked="" type="checkbox"/> N		8-9a	Yes
	55-80↑	40-50⇒	
●●●○	Any		
☾☾	High		
☀	M		
🦋	🐦		

provides food for wildlife; tolerates occasionally wet soil; medium to high wind resistance

Scientific Common
Reg/Native
G, H, S
Soil pH, Txt
Soil Mst, Drgt
Light/Best Salt
Wildlife



<i>Quercus virginiana</i> Live Oak	
N C S	8b-10b Yes
Fast	40-80↑ 60-120⇒
●●●○	Any
●●●●	High
☀ ☁	H
🦋 🐦	
provides food for wildlife; not for small lots; susceptible to caterpillars, root rot and insect galls; tolerates occasionally wet soil; high wind resistance	



<i>Simarouba glauca</i> Paradise Tree	
S	10b-11 Yes
Fast	30-50↑ 25-30⇒
●●●●	Any
●●●●	Medium
☀ ☁	H
🦋 🐦	
yellow, summer flowers; medium to high wind resistance; don't plant near sidewalks and driveways (surface roots)	



<i>Swietenia mahagoni</i> West Indian Mahogany	
S	10b-11 Yes
Fast	40-75↑ 40-60⇒
●●●●	Any
●●●●	High
☀ ☁	H
🦋 🐦	
medium to high wind resistance; tolerates occasionally wet soil; susceptible to webworms	



<i>Taxodium</i> spp. Pond Cypress, Bald Cypress	
N C S	8-10 Yes
Fast	50-80↑ 10-35⇒
●●●●	Any
●●●●	High
☀ ☁	M
🦋 🐦	
flammable plant - in wildfire prone areas, plant minimum 30' from buildings; wetland plant & adapts to dry sites; deciduous; yellow-brown fall color; small seeds provide food for wildlife; high wind resistance	

Scientific Common
Reg/Native
G, H, S
Soil pH, Txt
Soil Mst, Drgt
Light/Best Salt
Wildlife



<i>Ulmus alata</i> Winged Elm	
N C	8-9 Yes
Fast	45-70↑ 30-40⇒
●●●●	Any
●●●●	High
☀ ☁	M
🦋 🐦	
susceptible to Dutch elm disease; medium to high wind resistance	



<i>Ulmus americana</i> American Elm	
N C	8-9 Yes
Fast	70-90↑ 50-70⇒
●●●●	Any
●●●●	High
☀ ☁	M
🦋	
long-lived; susceptible to Dutch elm disease; medium to low wind resistance	



<i>Ulmus crassifolia</i> Cedar Elm	
N C	8-9 Yes
Fast	50-70↑ 40-60⇒
●●●●	Any
●●●●	High
☀ ☁	M
susceptible to Dutch elm disease and powdery mildew	



<i>Ulmus parvifolia</i> and cvs. Chinese Elm, Lacebark Elm	
N C	8-9 No
Fast	40-50↑ 35-50⇒
●●●●	Any
●●●●	High
☀ ☁	M
low wind resistance; susceptible to pests and freeze damage in North Florida; tolerates occasionally wet soil; form varies with cultivar	

Medium Trees

Scientific Common
Reg/Native
G, H, S
Soil pH, Txt
Soil Mst, Drgt
Light/Best Salt
Wildlife



Avicennia germinans
Black Mangrove

C	S	9a-11a	Yes
		20-30↑	10-20⇒
●●●●	S		
●		None	
☀️	☁️	H	
🦋			

white, year-round flowers attract bees; very good for salty shorelines with full sun; produces pneumatophores (breathing roots) that protrude around base of tree



Bursera simaruba
Gumbo Limbo

S	10b-11	Yes	
		20-50↑	25-40⇒
○●●●	Any		
●	High		
☀️	☁️	M	
🦋 🐦			

susceptible to pests if stressed; high wind resistance



Caesalpinia spp. and cvs.
Poinciana

C	S	9-11	No
		8-35↑	10-35⇒
○●●○	S/L		
●	●	Medium	
☀️	M		

choose species adapted to region; do not confuse with *Delonix regia*; flowers vary



Carpentaria acuminata
Carpentaria Palm

S	10b-11	No
Fast	35-40↑	8-10⇒
○●●○	Any	
●	●	Medium
☀️	L-N	

white/cream, spring through fall flowers; tolerates occasionally wet soil; can cause skin irritation

Scientific Common
Reg/Native
G, H, S
Soil pH, Txt
Soil Mst, Drgt
Light/Best Salt
Wildlife



Carpinus caroliniana
American Hornbeam,
Musclewood, Ironwood

N	C	8-9a	Yes
		20-30↑	20-30⇒
●●●○	Any		
●	●	Medium	
☀️	☁️	☁️	L-N
🐦			

orange/yellow, spring flowers; small enough to plant under powerlines; seeds and catkins provide food for wildlife; excellent understory tree; medium to high wind resistance



Cassia fistula
Golden Shower

S	10b-11	No
Fast	30-40↑	25-40⇒
○●●○	Any	
●	Medium	
☀️	L-N	
🦋		

yellow, summer flowers; showy blooms; low wind resistance



Cercis canadensis
Eastern Redbud

N	C	8b-9a	Yes
		20-30↑	15-35⇒
●●●○	Any		
●	High		
☀️	☁️	☁️	L-N
🦋 🐦			

cultivars provide variety of foliage and flower color; spring flowers; susceptible to pests; beans provide food for wildlife; medium to high wind resistance



Chrysophyllum oliviforme
Satinleaf

S	10b-11	Yes
Slow	30-45↑	18-25⇒
●●●○	Any	
●	High	
☀️	☁️	H
🐦		

fragrant flowers; provides food for wildlife; edible fruit; medium to high wind resistance

Scientific Common
Reg/Native
G, H, S
Soil pH, Txt
Soil Mst, Drgt
Light/Best Salt
Wildlife



<i>Coccotheca diversifolia</i> Pigeonplum
S 10a-11 Yes
Fast 30-40↑ 10-20⇒
●●●●○ S
High
☀ ☁ H
🐦
white, summer flowers; edible fruit; susceptible to weevils; provides food for wildlife; compact crown makes it good for small areas; medium to high wind resistance; bark peels and becomes showy with age



<i>Cordia sebestena</i> Geiger Tree
S 10b-11 No
Slow 25-30↑ 20-25⇒
○●●●● Any
High
☀ ☁ ☁ H
🦋 🐦
tolerant of salt or brackish water; orange, year-round flowers; foliage may be damaged by geiger beetles; damaged by severe freezes; high wind resistance



<i>Crataegus</i> spp. Hawthorn
N C 8-9 Var.
20-35↑ 15-40⇒
●●●●● Any
High
☀ ☁ L-N
🐦
provides food and cover for wildlife; flowers vary; best for North Florida; many species and cultivars



<i>Cupressus arizonica</i> var. <i>arizonica</i> Arizona Cypress
N C 8-9 Yes
30-40↑ 15-25⇒
●●●●● S/L
High
☀ U
evergreen; green foliage with silver/gray shimmer; good as specimen or windbreak

Scientific Common
Reg/Native
G, H, S
Soil pH, Txt
Soil Mst, Drgt
Light/Best Salt
Wildlife



<i>Delonix regia</i> Royal poinciana
S 10b-11 No
Fast 35-40↑ 40-60⇒
●●●●● Any
High
☀ M
🐦
orange/red, summer flowers; medium to low wind resistance; needs large area; caution - may be invasive in South Florida



<i>Elaeocarpus decipiens</i> Japanese Blueberry
N C S 8b-10b No
30-40↑ 30-40⇒
○●●●● Any
High
☀ ☁ U
🐦
evergreen; pink/white, spring through summer flowers; provides food for wildlife



<i>Ficus citrifolia</i> Shortleaf Fig, Wild Banyan Tree
S 10b-11 Yes
Fast 25-50↑ 30-40⇒
●●●●● Any
High
☀ ☁ M
🦋 🐦
edible fruit; lacks aerial roots, but still requires adequate room for root development; don't plant in drainfields due to aggressive roots; can be difficult to distinguish from invasive species



<i>Ilex X attenuata</i> and cvs. East Palatka Holly
N C S 8-10 Yes
30-45↑ 10-15⇒
●●●●○ Any
Medium
☀ ☁ M
🐦
may have severe disease problems in central parts of the state; provides pollen for bees

Medium Trees

Scientific Common
Reg/Native
G, H, S
Soil pH, Txt
Soil Mst, Drgt
Light/Best Salt
Wildlife



<i>Ilex cassine</i> and cvs. Dahoon Holly
N C S 8-10 Yes
20-30↑ 15-20⇒
●●○○ Any
☾☾ Medium
☀☁☁ M
🦋🐦
white, spring flowers; provides pollen for bees and berries for variety of wildlife; does best in rich, organic soils; high wind resistance



<i>Ilex opaca</i> American Holly
N C 8-9b Yes
35-50↑ 15-25⇒
●●●○ Any
☾☾☾ High
☀☁ M
🦋🐦
male and female flowers appear on separate trees, both sexes must be in same neighborhood for production of berries on female plants



<i>Ilex rotunda</i> Round Holly, Roundleaf Holly, Rotund Holly
N C S 8-11 No
Slow 20-30↑ 20-30⇒
●●○○ Any
☾ Medium
☀☁☁ L-N
🐦
white, spring flowers provide pollen for bees; provides food for wildlife



<i>Jacaranda mimosifolia</i> Jacaranda
C S 9b-11 No
Fast 25-40↑ 45-60⇒
○○●○ Any
☾ High
☀☁☁ L-N
🦋🐦
lavender/blue, spring through summer flowers; messy when leaves and flowers drop; soft wood, breaks easily; low wind resistance

Scientific Common
Reg/Native
G, H, S
Soil pH, Txt
Soil Mst, Drgt
Light/Best Salt
Wildlife



<i>Juniperus silicicola</i> Southern Red Cedar
N C S 8a-10b Yes
Fast 30-45↑ 20-30⇒
●●●● Any
☾ High
☀☁☁ H
🦋🐦
branches drooping; low wind resistance; provides food, cover, and nesting for birds; good for dunes; susceptible to pests such as juniper blight and mites



<i>Lagerstroemia indica</i> , <i>Lagerstroemia indica</i> X <i>fauriei</i> , <i>Lagerstroemia fauriei</i> Crapemyrtle
N C S 8-10b No
Fast 10-30↑ 15-30⇒
●●●● Any
☾☾ High
☀☁ L-N
🐦
form, size, disease resistance, bloom season, flower and bark color vary with cultivar; plant for good air circulation; high wind resistance; susceptible to aphids and sooty mold; bark peels and becomes showy with age



<i>Ostrya virginiana</i> American Hophornbeam, American Hornbeam
N C 8-9a Yes
Slow 30-40↑ 25-30⇒
●●●○ Any
☾ High
☀☁☁ L-N
🐦
fall color; nuts provide food for wildlife; medium to high wind resistance



<i>Persea borbonia</i> Red Bay, Bay Oak
N C S 8b-11 Yes
30-50↑ 30-50⇒
●●●○ Any
☾☾☾ High
☀☁☁ H
🦋🐦
larval food plant for swallowtail butterflies; insect galls can distort leaves; medium to low wind resistance

Scientific Common
Reg/Native
G, H, S
Soil pH, Txt
Soil Mst, Drgt
Light/Best Salt
Wildlife



<i>Persea palustris</i> Swamp Bay
N C S 8-10 Yes
20-30↑ 20-30⇒
●●●○ Any
☾● Medium
☀ ☁ L-N
🦋 🐦
purple fruit; good wetland plant



<i>Podocarpus gracilior</i> Weeping Fern Pine, Weeping Podocarpus
C S 9b-11 No
Slow 30-50↑ 25-35⇒
●●●○ Any
☾ Medium
☀ ☁ L-N
grows slower in full shade; high wind resistance



<i>Quercus lyrata</i> Overcup Oak
N C 8-9a Yes
30-40↑ 30-40⇒
●●●○ Any
☾☾ Medium
☀ ☁ L-N
🐦
tolerates occasionally wet soil; provides food for wildlife



<i>Rhizophora mangle</i> Red Mangrove
S 10-11 Yes
20-40↑ 30-40⇒
●●●○ Any
☾ Medium
☀ H
🦋
yellow, year-round flowers

Scientific Common
Reg/Native
G, H, S
Soil pH, Txt
Soil Mst, Drgt
Light/Best Salt
Wildlife



<i>Tabebuia chrysostricha</i> Yellow Trumpet Tree, Golden Trumpet Tree
C S 9b-11 No
25-35↑ 25-35⇒
●●●● Any
☾ Medium
☀ M
yellow, spring flowers; medium to low wind resistance



<i>Tabebuia heterophylla</i> Pink Trumpet Tree
C S 9b-11 No
20-30↑ 15-25⇒
●●●● Any
☾ High
☀ M-H
pink/white, spring through summer flowers; medium to low wind resistance; suscepti- ble to holopothrips



<i>Tabebuia impetiginosa</i> Purple Trumpet Tree
C S 9b-11 No
12-18↑ 10-15⇒
●●●● Any
☾ High
☀ M
showy, pinkish-purple, spring flowers; medium to low wind resistance



<i>Zanthoxylum clava-herculis</i> Hercules' Club
N C 8-9b Yes
15-30↑ 10-20⇒
○●●○ C/L
☾ Low
☀ ☁ U
🦋
deciduous; spines; host plant for Giant Swallowtail butterfly; white, spring flowers

Small Trees

Scientific Common
Reg/Native
G, H, S
Soil pH, Txt
Soil Mst, Drgt
Light/Best Salt
Wildlife



<i>Acacia farnesiana</i> Sweet Acacia	
C S	9-11 Yes
Slow	10-25↑ 15-25⇒
○○○○○	S/C
☾☾	High
☀☁☁	M
🐦	
also known as <i>Acacia smallii</i> ; yellow, year-round flowers; thorny; tolerates occasionally wet soil; provides food and cover for birds and insects; don't plant next to sidewalk	



<i>Aesculus pavia</i> Red Buckeye, Florida Buckeye	
N	8-9a Yes
	15-20↑ 15-25⇒
○○○○○	Any
☾☾	Medium
☀☁☁	M
🦋🐦	
attractive bark; red, spring flowers; tolerates occasionally wet soil; poisonous seeds	



<i>Aralia spinosa</i> Devil's Walkingstick	
N C	8-9a Yes
	10-25↑ 6-10⇒
○○○○○	Any
☾☾	Medium
☀☁☁	L-N
🦋🐦	
also known as <i>Angelica spinosa</i> ; small, white, spring through summer flowers; purplish berries provide food for wildlife; sharp thorns; tolerates occasionally wet soil; can sucker to produce a thicket	



<i>Ardisia escallonioides</i> Marlberry, Marbleberry	
C S	9-11 Yes
	10-20↑ 3-12⇒
○○○○○	S/L
☾☾	High
☀☁☁	H
🐦	
fragrant, white, year-round flowers; attractive foliage; round purple fruit provide food for wildlife mostly in fall and winter; good for screens and hedges	



<i>Arenga engleri</i> Formosa Palm, Dwarf Sugar Palm	
C S	9a-11 No
Slow	6-10↑ 10-16⇒
○○○○○	Any
☾	None
☀☁☁	L-N
🐦	
red/orange/green, spring flowers; grows in clusters	



<i>Baccharis halimifolia</i> Groundsel Bush, Sea Myrtle, Salt-bush	
N C S	8-10 Yes
	8-12↑ 6-12⇒
○○○○○	Any
☾☾☾	Medium
☀☁☁	M
feathery, white, fall flowers; poisonous seeds; useful for wet sites such as retention ponds and ditches; can spread from seed	



<i>Butia capitata</i> Pindo Palm, Jelly Palm	
N C S	8b-11 No
Slow	15-25↑ 15-25⇒
○○○○○	Any
☾	High
☀☁☁	M
edible fruit used for jelly; provides food for wildlife; looks best in full sun; white flowers; susceptible to pests; high wind resistance	



<i>Calliandra</i> spp. and cvs. Powderpuff	
C S	9b-11 No
Fast	10-15↑ 8-15⇒
○○○○○	Any
☾	High
☀☁☁	L-N
🦋🐦	
pink/white, fall through spring flowers; only <i>Calliandra haematocephala</i> assessed as not a problem	

Scientific Common
Reg/Native
G, H, S
Soil pH, Txt
Soil Mst, Drgt
Light/Best Salt
Wildlife



<i>Callistemon</i> spp. Bottlebrush
N C S 8b-11 No
Slow 6-30↑ 6-15⇒
○●●○ S/L
High
☀ ☁ M
🦋 🐦
red, spring through summer flowers; medium to low wind resistance; attracts beneficial insects; only <i>C. citrinus</i> , <i>C. rigidus</i> , assessed as not a problem



<i>Camellia japonica</i> Camellia
N C 8-9 No
Slow 10-20↑ 10-20⇒
●●●○ Any
Medium
☀ ☁ L-N
many cvs. with a variety of flower colors; up to 6 inches, in winter through spring; susceptible to scales, aphids, chewing insects and fungus; requires acid soil and has problems if pH is too high



<i>Camellia sasanqua</i> Sasanqua, Sasanqua Camellia
N C 8-9 No
Slow 3-15↑ 5-10⇒
●●●○ Any
Medium
☀ ☁ L-N
some groundcover cvs. available; fall through winter flowers, colors vary; susceptible to scales, mites, aphids and chewing insects; requires acid soil and has problems if pH is too high



<i>Canella winterana</i> Wild Cinnamon, Cinnamon Bark
S 10b-11 Yes
Slow 10-30↑ 10-30⇒
○●●● S/L
High
☀ ☁ H
purple, summer flowers

Scientific Common
Reg/Native
G, H, S
Soil pH, Txt
Soil Mst, Drgt
Light/Best Salt
Wildlife



<i>Capparis cynophallophora</i> Jamaica Caper Tree, Mustard Tree
S 10-11 Yes
Slow 6-20↑ 6-15⇒
○●●● Any
High
☀ ☁ H
🦋
purple/white, spring flowers



<i>Cephalanthus occidentalis</i> Buttonbush
N C S 8-11 Yes
6-20↑ 6-8⇒
●●●○ Any
None
☀ ☁ L-N
🦋 🐦
flammable plant - in wildfire prone areas, plant minimum 30' from buildings; attracts insects; white, spring flowers; good for retention ponds/swales/canal banks; well adapted to disturbed soils



<i>Cephalotaxus harringtonia</i> Japanese Plum Yew, Harrington Plum Yew
N C 8-9 No
Slow 3-10↑ 5-10⇒
●●●○ S
Medium
☀ ☁ L-N
dark green foliage; suitable for use as a hedge or specimen plant



<i>Cercis reniformis</i> 'Oklahoma' Oklahoma Redbud
N C 6b-9a Yes
Fast 20-25↑ 15-20⇒
●●●● Any
High
☀ ☁ L-N
showy flowers which cover tree in the spring

Small Trees

Scientific Common
Reg/Native
G, H, S
Soil pH, Txt
Soil Mst, Drgt
Light/Best Salt
Wildlife



<i>Chamaerops humilis</i> European Fan Palm	
N C S	8-11 No
Fast	5-15↑ 6-15⇒
●●●○	Any
☾	High
☀ ☁	M
🐦	
clumping palm; yellow, summer flowers; pest sensitive; very cold hardy; low maintenance compared to other palms; petioles with sharp teeth	



<i>Chionanthus retusus</i> Chinese Fringetree	
N	8 No
Slow	15-30↑ 10-12⇒
●●●○	S
☾	Medium
☀ ☁	L-N
🐦	
white, spring through summer flowers; grows very slowly, usually 4 to 10 inches per year, but can grow a foot per year if given rich, moist soil and appropriate fertilization	



<i>Chionanthus virginicus</i> Fringetree	
N C	8-9 Yes
Slow	12-20↑ 10-15⇒
●●●○	Any
☾	Medium
☀ ☁	L-N
🐦	
showy, white, spring flowers; flowers best in sun; pest sensitive; tolerates occasionally wet soil; medium to high wind resistance	



<i>Citharexylum spinosum</i> Fiddlewood	
S	10-11 Yes
	15-25↑ 8-15⇒
●●●○	Any
☾	High
☀ ☁	H
🦋 🐦	
also known as <i>Citharexylum fruticosum</i> ; white, fragrant flowers all year; provides food for wildlife; useful as a tall hedge	



<i>Coccoloba uvifera</i> Seagrape	
C S	9-11 Yes
	3-35↑ 10-50⇒
●●●○	S
☾	High
☀ ☁	H
🦋 🐦	
deciduous with continual leaf drop; fragrant, white, spring flowers; provides food for large wildlife; susceptible to weevils; grows as shrub on coastal dunes and as tree inland; medium to high wind resistance	



<i>Cordia boissieri</i> White Geiger, Texas Olive	
C S	9a-11 No
Slow	15-20↑ 10-15⇒
○●●●	Any
☾	High
☀ ☁	M
🐦	
white, year-round flowers	



<i>Cornus foemina</i> Swamp Dogwood, Stiff Dogwood, Stiff Cornel	
N C S	8-10 Yes
	10-16↑ 10-16⇒
○●●○	Any
☾	Low
☀ ☁	L-N
🐦	
white, spring flowers; blue berries provide food for wildlife; larval food plant for spring azure butterfly; susceptible to borers	



<i>Cornus florida</i> Flowering Dogwood	
N	8-9a Yes
	25-30↑ 25-30⇒
●●●○	Any
☾	Medium
☀ ☁	L-N
🦋 🐦	
prefers deep, rich, well-drained sandy or clay soils and has a moderately long life; roots rot in soils without adequate drainage; susceptible to pests and disease	

Scientific Common
Reg/Native
G, H, S
Soil pH, Txt
Soil Mst, Drgt
Light/Best Salt
Wildlife



<i>Crossopetalum rhacoma</i> Maidenberry
C S 9b-11 Yes
Slow 1½-6↑ 3-8⇒
●●●● S
High
M-H
Wildlife
large red berries have ornamental value, making this a good accent plant



<i>Cyrilla racemiflora</i> Titi, Swamp Cyrilla, Leatherwood
N C 8b-10a Yes
Fast 10-30↑ 6-15⇒
●●●○ Any
Medium
L-N
Wildlife
white, spring through summer flowers; wetland plant; good for edges of retention ponds; attractive to bees



<i>Dodonaea viscosa</i> Hopbush, Varnish Leaf
C S 9-11 Yes
10-18↑ 6-15⇒
●●●● S/L
High
H
Wildlife
yellow, summer through fall flowers; showy, colorful fruit



<i>Eriobotrya japonica</i> Loquat
N C S 8-11 No
20-30↑ 30-35⇒
●●●● Any
Medium
M
Wildlife
white, fall through winter flowers; medium to low wind resistance; susceptible to pests; caution - may be invasive in Central and South Florida

Scientific Common
Reg/Native
G, H, S
Soil pH, Txt
Soil Mst, Drgt
Light/Best Salt
Wildlife



<i>Eugenia</i> spp. (natives only) Stoppers
C S 9-11 Yes
10-30↑ 5-20⇒
●●●● Any
High
H
Wildlife
flowers vary; needs little attention once established; natives are <i>E. axillaris</i> , <i>E. foetida</i> , <i>E. rhombea</i> , and <i>E.confusa</i> ; <i>E. axillaris</i> , <i>E. confusa</i> , <i>E. foetida</i> have high wind resistance



<i>Forestiera segregata</i> Florida Privet
N C S 8b-11 Yes
4-15↑ 3-12⇒
○●●● S/L
High
H
Wildlife
semi-evergreen to evergreen; yellow, early spring flowers; great hedge plant; provides food for wildlife; flowers attract insects



<i>Ilex</i> X'Mary Nell' Mary Nell Holly
N C 8-9 Yes
10-20↑ 10-15⇒
●●●○ S/C
Medium
M
Wildlife
white; spring flowers; important source of pollen for bees



<i>Ilex</i> X'Nellie R. Stevens' Nellie R. Stevens Holly
N C 8-9 Yes
15-25↑ 10-12⇒
●●●○ S/C
Medium
M
Wildlife
white, spring flowers; important source of pollen for bees; provides food for wildlife

Small Trees

Scientific Common
Reg/Native
G, H, S
Soil pH, Txt
Soil Mst, Drgt
Light/Best Salt
Wildlife



<i>Ilex cornuta</i> and cvs. Chinese Holly, Horned Holly	
N C	8-9 No
8-25↑ 8-25⇒	
●●○○	Any
High	
☀ ☁	M
	🐦
susceptible to tea scale, especially in cool, shady areas; provides food for wildlife; many cultivars available; important source of pollen for bees	



<i>Ilex decidua</i> Possumhaw	
N	8-9a Yes
Slow	10-15↑ 10-15⇒
●●●●	Any
High	
☀ ☁ ☁	U
	🐦
small, white, spring flowers; small orange/red fruit provide food for wildlife; be sure to purchase female trees for fruit production	



<i>Ilex glabra</i> Gallberry	
N C S	8-10a Yes
Slow	6-8↑ 8-10⇒
●●○○	Any
Medium	
☁	M
	🐦
flammable plant - in wildfire prone areas, plant minimum 30' from buildings; white, spring flowers; black fruit provides food for wildlife in late fall and winter; good for wetland/pine areas; high wind	



<i>Ilex vomitoria</i> and cvs. Yaupon Holly	
N C S	8-10 Yes
15-30↑ 6-20⇒	
●●●○	Any
High	
☀ ☁	H
	🦋 🐦
flammable, in wildfire prone areas, plant minimum 30' from buildings; white, spring through summer flowers; red fruit on female plants provides food for wildlife in late fall and winter; 'Pendula' - FNGLA Plant of the Year, 2005; high wind resistance; can sucker to produce a thicket	

Scientific Common
Reg/Native
G, H, S
Soil pH, Txt
Soil Mst, Drgt
Light/Best Salt
Wildlife



<i>Illicium</i> spp. Star Anise	
N C	8-9 Var.
10-15↑ 6-15⇒	
●●○○	Any
Medium	
☀ ☁	L-N
evergreen, yellowish-white or greenish-white flowers	



<i>Jatropha integerrima</i> Peregrina	
C S	9b-11 No
8-15↑ 5-10⇒	
●●●●	Any
High	
☀ ☁	L-N
	🦋 🐦
scarlet, year-round flowers; poisonous; susceptible to pests and disease; sensitive to frost	



<i>Krugiodendron ferreum</i> Black Ironwood	
C S	9b-11b Yes
Slow	20-30↑
●●●●	S/L
High	
☀	H
	🐦
very dense wood	



<i>Ligustrum japonicum</i> and cvs. Ligustrum, Japanese Privet	
N C S	8-10b No
8-12↑ 15-25⇒	
○●●○	Any
Medium	
☀ ☁	H
white, summer flowers; susceptible to pests and diseases; used as hedge; thins at bottom unless in full sun	

Scientific Common
Reg/Native
G, H, S
Soil pH, Txt
Soil Mst, Drgt
Light/Best Salt
Wildlife



Magnolia X soulangiana
and cvs.
Saucer Magnolia

N	C	8-9a	No
		20-25↑ 15-25⇒	
●●●○	Any		
☾	Low		
☀ ☁	L-N		

many cultivars; pink/ white/ lavender, fragrant, winter through spring flowers; susceptible to pests; medium to high wind resistance



Magnolia figo
Banana Shrub

N	C	8-10	Yes
		10-20↑ 6-15⇒	
●●●○	Any		
☾	Medium		
☀ ☁ ☁	U		

also known as *Michelia figo*; light-yellow, spring through early summer flowers; fragrance similar to ripening cantaloupes or bananas; generally used as specimen plant; susceptible to scale and mushroom root rot



Musa spp.
Banana

C	S	9b-11	No
Fast		7-30↑ 10-15⇒	
●●●●	Any		
☾	Low		
☀ ☁	L-N		

edible fruit; showy purple or orange flowers; needs regular watering; susceptible to disease, pests, and frost



Myrcianthes fragrans
Simpson's Stopper,
Twinberry

C	S	9b-11	Yes
		6-30↑ 15-20⇒	
○●●○	Any		
☾	High		
☀ ☁ ☁	H		

edible fruit; white, fragrant, year-round flowers; red berries provide food for wildlife; tolerates occasionally wet soil; needs little attention once established

Scientific Common
Reg/Native
G, H, S
Soil pH, Txt
Soil Mst, Drgt
Light/Best Salt
Wildlife



Myrciaria cauliflora
Jaboticaba, Brazilian Grape Tree, Brazilian Grape

	S	10b-11	No
Slow		15-40↑ 15-40⇒	
●●●●	Any		
☾	Medium		
☀ ☁	L-N		

edible, black fruit; white flowers, time of flowering depends on cultivar



Myrica cerifera and cvs.
Wax Myrtle

N	C	S	8-10	Yes
Fast			10-40↑ 20-25⇒	
●●●●	Any			
☾	Medium			
☀ ☁	H			

flammable, in wildfire prone areas, plant minimum 30' from buildings; silver berries found on female plants only; susceptible to disease; good hedge plant; provides food and cover for wildlife; medium to low wind resistance, can sucker to produce a thicket



Olea europaea
Olive

N	C	S	8-11	No
Slow			25-50↑ 35-50⇒	
●●●●	S/L			
☾	Medium			
☀	M			

makes a great landscape plant; requires a pollinator to fruit



Osmanthus americanus
Wild Olive, Devilwood

N	C	8-9	Yes
		15-25↑ 10-15⇒	
○●●○	Any		
☾	Medium		
☀ ☁	H		

white, fragrant, spring flowers; provides food for wildlife

Small Trees

Scientific Common
Reg/Native
G, H, S
Soil pH, Txt
Soil Mst, Drgt
Light/Best Salt
Wildlife



<i>Plumeria rubra</i> Frangipani, Nosegay, Templetree	
S	10b-11 No
Slow	20-25↑ 20-25⇒
●●●●	Any
☾	High
☀ ☁	H
fragrant, showy, spring through fall flowers; susceptible to frangipani caterpillar; needs cold-protected spot if grown in central Florida	



<i>Podocarpus macrophyllus</i> and cvs. Podocarpus	
N C S	8b-11 No
Slow	30-40↑ 20-25⇒
●●●○	S/C
☾	High
☀ ☁	H
dark green, evergreen leaves; small, purple, fruit on females provide food for wildlife; high wind resistance; mildly susceptible to pests and diseases; some magnesium deficiency on sandy soils	



<i>Prunus angustifolia</i> Chickasaw Plum	
N C	8-9 Yes
	12-20↑ 15-20⇒
●●●○	Any
☾	High
☀ ☁	M
butterfly	
white, winter flowers; reddish plums provide food for wildlife; medium to high wind resistance; can sucker to produce a thicket	



<i>Prunus campanulata</i> Taiwan Cherry	
N	8-9a No
	12-20↑ 15-25⇒
●●●○	Any
☾	Medium
☀ ☁	U
bird	
small pink, late winter flowers; small fruit provides food for wildlife; susceptible to tent caterpillar	

Scientific Common
Reg/Native
G, H, S
Soil pH, Txt
Soil Mst, Drgt
Light/Best Salt
Wildlife



<i>Prunus umbellata</i> Flatwoods Plum	
N C	8-9 Yes
	12-20↑ 12-20⇒
●●●○	Any
☾	Medium
☀ ☁	L-N
butterfly	
white, spring flowers; purple plums provide food for wildlife; edible fruits, ranging from very tart to sweet; susceptible to tent caterpillars; can sucker to produce a thicket	



<i>Quercus geminata</i> Sand Live Oak, Small Sand Live Oak	
N C S	8-10a Yes
	35-50↑ 45-60⇒
○●●○	S/L
☾	High
☀	H
bird	
high wind resistance; good in dune areas; provides food for wildlife; FNGLA Plant of the Year 2008	



<i>Raphiolepis</i> spp. and cvs. Indian Hawthorn	
N C	8-9 No
	2-10↑ 2-6⇒
○●●○	Any
☾	High
☀ ☁	M
flowers vary; provides food for wildlife; use disease-resistant cvs., plant in full sun; susceptible to disease	



<i>Senna polyphylla</i> Desert Cassia	
S	10a-11 No
Fast	6-10↑ 6-8⇒
○●●●	S/L
☾	Medium
☀ ☁	H
yellow, summer flowers; should not be confused with <i>Senna pendula</i>	

Scientific Common
Reg/Native
G, H, S
Soil pH, Txt
Soil Mst, Drgt
Light/Best Salt
Wildlife



Sideroxylon spp. (natives only)
Buckthorn

N C S 8-11 Yes

50-75↑ 35-50⇒

●●●● Any

High

☀️ ☁️ H

Wildlife

good coastal or dune plant; select species based on region, soil texture, and drainage; flowers vary



Sophora tomentosa
Necklace Pod

S 10-11 Yes

6-10↑ 8-12⇒

●●●● S/L

High

☀️ H

Wildlife

evergreen shrub; weeping shape; yellow, year-round flowers; seeds are poisonous; provides food for wildlife



Tabebuia aurea
Silver Trumpet Tree,
Yellow Tab

S 10-11 No

15-25↑ 10-15⇒

●●●● Any

High

☀️ ☁️ M

Wildlife

yellow, winter through spring flowers; flowers emerge after leaves drop; not wind resistant



Viburnum obovatum and cvs.
Walter's Viburnum

N C S 8-10 Yes

8-25↑ 6-10⇒

●●●● Any

High

☀️ ☁️ L-N

Wildlife

white, winter through spring flowers; small black fruit provides food for wildlife; provides nesting cover for wildlife; can sucker to produce a thicket; dwarf cvs. are 2' to 4' tall

Scientific Common
Reg/Native
G, H, S
Soil pH, Txt
Soil Mst, Drgt
Light/Best Salt
Wildlife



Viburnum odoratissimum
Sweet Viburnum

N C S 8b-10a No

Fast 15-30↑ 15-25⇒

●●●● Any

Medium

☀️ ☁️ L-N

Wildlife

white, spring flowers; susceptible pests and disease; often grown as a hedge; thins in shaded sites



Viburnum odoratissimum
var. *awabuki*
Awabuki Viburnum

N C S 8-10b No

Slow 15-20↑ 15-20⇒

●●●○ Any

Medium

☀️ ☁️ L-N

Wildlife

also known as *Viburnum awabuki*; fragrant, small white, spring flowers; red/black fruit provides food for wildlife; takes well to pruning; used for hedges; susceptible to pests and disease



Viburnum rufidulum
Rusty Blackhaw, Southern Blackhaw

N 8b-9a Yes

Slow 20-25↑ 20-25⇒

●●●● Any

High

☀️ ☁️ H

Wildlife

scarlet to purple fall foliage; clusters of small, white, spring flowers; small black fruit provides food for wildlife; tolerates occasionally wet soil; will not tolerate compacted soils

Large Shrubs

Scientific Common
Reg/Native
G, H, S
Soil pH, Txt
Soil Mst, Drgt
Light/Best Salt
Wildlife



<i>Abelia Xgrandiflora</i> Glossy Abelia	
N C	8-9 No
6-10↑ 6-10⇒	
●●●○	S/C
☾	Medium
☀ ☁ ☁	L-N
🦋	
fine textured, semi-evergreen; red-tinged leaves; pink/white, spring through fall flowers; doesn't flower in the shade	



<i>Acacia farnesiana</i> Sweet Acacia	
C S	9-11 Yes
Slow	10-25↑ 15-25⇒
●●●○	S/C
☾ ☾	High
☀ ☁ ☁	M
🐦	
also known as <i>Acacia smallii</i> ; yellow, year-round flowers; thorny; tolerates occasionally wet soil; provides food and cover for birds and insects; don't plant next to sidewalk	



<i>Acalypha wilkesiana</i> Copper Leaf	
S	10b-11 No
Fast	8-12↑ 6-8⇒
●●●○	Any
☾	Medium
☀ ☁ ☁	U
provides continuous color in the landscape; heart-shaped leaves in varying mottled combinations of colors; susceptible to pests	



<i>Feijoa sellowiana</i> Pineapple Guava, Feijoa	
N C S	8-11 No
	8-15↑ 8-15⇒
○●●○	S/C
☾	High
☀ ☁ ☁	L-N
also known as <i>Feijoa sellowiana</i> ; red/white, spring flowers; often used as a hedge; provides food/cover/ nesting for wildlife	



<i>Acrostichum danaeifolium</i> Leather Fern	
C S	9-11 Yes
4-8↑ 3-5⇒	
●●●○	Any
☾ ☾	Low
☀ ☁ ☁	M
large fern; good for wet sites in shaded landscape; prolonged sunlight, especially in the summer, can burn foliage	



<i>Agarista populifolia</i> Pipestem, Fetterbush, Doghobble	
N C	8-9 Yes
	8-12↑ 5-10⇒
●●●○	S/C
☾ ☾ ☾	Medium
☀ ☁ ☁	L-N
evergreen, creamy white, fragrant spring flowers	



<i>Agave</i> spp. Century plant, Agave	
N C S	var. Var.
Slow	3-6↑ 3-10⇒
○●●○	S
☾	High
☀ ☁ ☁	H
dramatic foliage and form; evergreen, silver/gray to blue-green foliage; showy, green-brown fruit; sharp spines; choose species adapted to climate	

Scientific Common
Reg/Native
G, H, S
Soil pH, Txt
Soil Mst, Drgt
Light/Best Salt
Wildlife



<i>Aloysia virgata</i> Sweet Almond Bush
N C S 8-11 No
6-12↑ 6-12⇨
●●●● Any
☹ High
☀ U
🦋
evergreen; white, fragrant, summer through fall flowers



<i>Aralia spinosa</i> Devil's Walkingstick
N C 8-9a Yes
10-25↑ 6-10⇨
○●●○ Any
☹ Medium
☀ ☁ ☁ L-N
🦋 🐦
also known as <i>Angelica spinosa</i> ; small white, spring through summer flowers; purplish berries provide food for wildlife; spiny stems; tolerates occasionally wet soil



<i>Ardisia escallonioides</i> Marlberry, Marbleberry
C S 9-11 Yes
10-20↑ 3-12⇨
○●●● S/L
☹ High
☀ ☁ ☁ H
🐦
fragrant, white, year-round flowers; attractive foliage; round, purple fruits provide food for wildlife, mostly in fall and winter; good for screens and hedges



<i>Asimina</i> spp. Pawpaw
N C S 8-10 Var.
15-20↑ 15-20⇨
○●○○ S
☹ Medium
☀ ☁ ☁ L-N
🦋
deciduous; species needs vary, choose based on conditions; flowers vary; larval food plant for zebra swallowtail butterfly; does not transplant well

Scientific Common
Reg/Native
G, H, S
Soil pH, Txt
Soil Mst, Drgt
Light/Best Salt
Wildlife



<i>Baccharis halimifolia</i> Groundsel Bush, Sea Myrtle, Salt-bush
N C S 8-10 Yes
8-12↑ 6-12⇨
●●●● Any
☹ Medium
☀ M
feathery, white, fall flowers; poisonous seeds; useful for wet sites such as retention ponds and ditches; can spread by suckers from roots



<i>Bambusa</i> spp. (clumping types only) Bamboo
N C S 8-11 No
3-100↑ 2-20⇨
○●●○ Any
☹ Medium
☀ ☁ M
choose species adapted to conditions; bamboo grows aggressively; should not be planted near lakefronts or streams; except for <i>Bambusa arundinacea</i>



<i>Barleria micans</i> Yellow Shrimp Plant
S 10-11 No
Fast 4-5↑ 4-5⇨
○●●○ Any
☹ Medium
☀ ☁ U
evergreen shrub with upright growth that terminates in flattish spikes that produce lobed, bright, yellow flowers; provides food for wildlife



<i>Berberis julianae</i> Wintergreen Barberry, Julian's berberis
N 8-9a No
Slow 4-6↑ 2-5⇨
○●●○ Any
☹ Medium
☀ ☁ M
evergreen; yellow, winter through spring flowers; red fruit; adaptable to a wide range of soil conditions but does best in rich, organic soil; requires pruning to maintain best form; spiny; good hedge or barrier plant

Large Shrubs

Scientific Common
Reg/Native
G, H, S
Soil pH, Txt
Soil Mst, Drgt
Light/Best Salt
Wildlife



<i>Brugmansia X candida</i> Angel's Trumpet
S 10b-11 No
8-14↑ 10-15⇒
●●●○ Any
Low
☀ ☁ L-N
flowers hang from stems and branches and drape the plant with color; good specimen tree; susceptible to pests and diseases



<i>Brunfelsia grandiflora</i> Yesterday-Today-and-Tomorrow
N C S 8b-11 No
7-10↑ 5-8⇒
○●●○ Any
Medium
☀ ☁ ☁ L-N
white/purple, spring through fall flowers



<i>Buddleja lindleyana</i> Butterfly Bush, Lindley's Butterfly Bush
N C 8-9 No
Fast 4-6↑ 4-6⇒
○●●○ Any
Medium
☀ M
☦
deciduous, non-fragrant, purple/violet flowers; excellent for butterflies; aggressive suckering and spreads through runners



<i>Byrsonima lucida</i> Long Key Locustberry
S 10b-11 Yes
12-20↑ 15-30⇒
●○○○ S/L
High
☀ ☁ M
☦
plant has winter interest due to unusual form, nice persistent fruits, showy winter trunk, or winter flowers



<i>Calliandra haematocephala</i> Red Powderpuff
C S 9-11 No
6-8↑ 8-12⇒
●●●○ Any
High
☀ ☁ L-N
possible cold damage from freezing temperatures; large fragrant flower blooms during warm months; susceptible to pests



<i>Callicarpa americana</i> Beautyberry
N C S 8-10 Yes
6-8↑ 6-8⇒
●●●○ Any
High
☀ ☁ ☁ L-N
☦
deciduous; purple/light purple spring through fall flowers; attracts wildlife; small purplish fruits provide food for wildlife in late winter; need to prune old wood since flowers and fruit are produced on new growth



<i>Callistemon</i> spp. Bottlebrush
N C S 8b-11 No
6-30↑ 6-15⇒
○●●○ S/L
High
☀ ☁ M
☦ ☦
red spring though summer flowers; medium to low wind resistance; attracts beneficial insects; check with your local Extension office before final species selection; except <i>Callistemon viminalis</i>



<i>Calycanthus floridus</i> Carolina Allspice, Eastern Sweetshrub
N C S 8-10a Yes
Slow 6-9↑ 6-12⇒
●●●● Any
Medium
☀ ☁ L-N
good screen; red, spring through summer flowers with strawberry-like fragrance; does best in rich, organic soil

Scientific Common
Reg/Native
G, H, S
Soil pH, Txt
Soil Mst, Drgt
Light/Best Salt
Wildlife



<i>Camellia japonica</i> Camellia
N C 8-9 No
Slow 10-20↑ 10-20⇒
●●●○ Any
☹ Medium
☀ ☁ L-N
many cultivars; flowers up to 6 inches, in winter through spring, color variable; susceptible to pests and diseases; requires acidic soil and has problems if pH is too high



<i>Camellia sasanqua</i> Sasanqua, Sasanqua Camellia
N C 8-9 No
Slow 3-15↑ 5-10⇒
●●●○ Any
☹ Medium
☀ ☁ ☁ L-N
some groundcover cultivars available; fall through winter flowers, color variable; susceptible to pests; requires acidic soil and has problems if pH is too high



<i>Capparis cynophallophora</i> Jamaica Caper Tree, Mustard Tree
S 10-11 Yes
Slow 6-20↑ 6-15⇒
○●●● Any
☹ High
☀ ☁ H
🦋
purple/white, spring flowers



<i>Carissa macrocarpa</i> Natal Plum
C S 9-11 No
2-20↑ 2-20⇒
○●●● S
☹ High
☀ ☁ H
also known as <i>Carissa grandiflora</i> ; edible fruit; white, fragrant year-round flowers

Scientific Common
Reg/Native
G, H, S
Soil pH, Txt
Soil Mst, Drgt
Light/Best Salt
Wildlife



<i>Cephalanthus occidentalis</i> Buttonbush
N C 8-9 Yes
6-20↑ 6-8⇒
●●●○ Any
☹☹ None
☀ ☁ L-N
🦋 🐦
flammable, in wildfire prone areas, plant minimum 30' from buildings; attracts insects; white, spring through summer flowers; grows well in wet areas such as detention ponds or drainage ditches; well adapted to disturbed soils



<i>Cephalotaxus harringtonia</i> Japanese Plum Yew, Harrington Plum Yew
N C 8-9 No
Slow 3-10↑ 5-10⇒
●●●○ S
☹ Medium
☀ ☁ ☁ L-N
dark green foliage; suitable for use as a hedge or specimen plant



<i>Cestrum aurantiacum</i> Orange Jessamine
C S 9-11 No
Fast 4-10↑ 6-8⇒
○●●○ Any
☹ Medium
☀ ☁ M
🦋 🐦 🐦
yellow/orange, spring through summer flowers

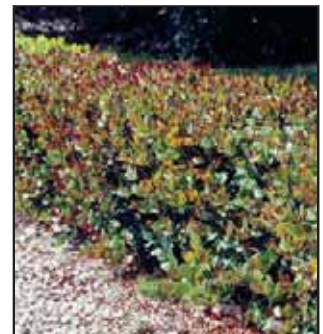

<i>Chrysobalanus icaco</i> Cocoplum
S 10-11 Yes
3-30↑ 10-20⇒
○●●○ Any
☹ Medium
☀ ☁ H
🦋 🐦
white, year-round flowers; edible fruit; good hedge or screen plant; purple "plums" provide food for wildlife; high wind resistance

Large Shrubs

Scientific Common
Reg/Native
G, H, S
Soil pH, Txt
Soil Mst, Drgt
Light/Best Salt
Wildlife



<i>Citharexylum spinosum</i> Fiddlewood		
S	10-11	Yes
	15-25↑ 8-12⇨	
●●●○	Any	
☹	High	
☀ ☁	M	
🦋 🐦		
also known as <i>Citharexylum fruticosum</i> ; white, fragrant, year-round flowers; provides food for wildlife; useful as a tall hedge		



<i>Clethra alnifolia</i> Sweet Pepperbush		
N C	8-9	Yes
	4-8↑ 4-8⇨	
●●●○	Any	
☹☹	Medium	
☀ ☁ ☁	M	
🦋		
white, fragrant, summer flowers; attracts bees and other wildlife; grows well in wet areas		



<i>Clusia rosea</i> 'nana' Dwarf Pitch Apple		
S	10b-11	No
●●●●	Any	
☹	High	
☀ ☁ ☁	H	



<i>Coccoloba uvifera</i> Seagrape		
C S	9-11	Yes
	3-35↑ 10-50⇨	
●●●○	S	
☹	High	
☀ ☁	H	
🦋 🐦		
deciduous with continual leaf drop; fragrant, white, spring flowers; provides food for large wildlife; susceptible to weevils; grows as shrub on coastal dunes and as tree inland; medium to high wind resistance		

Scientific Common
Reg/Native
G, H, S
Soil pH, Txt
Soil Mst, Drgt
Light/Best Salt
Wildlife



<i>Cocculus laurifolius</i> Laurelleaf Snailseed, Carolina Coralbead, Cocculus		
C S	9a-11	No
	12-18↑ 18-20⇨	
○●●○	Any	
☹☹	High	
☀ ☁	M	
spreading growth habit; yellow flowers		



<i>Codiaeum variegatum</i> Croton		
S	10b-11	No
	3-8↑ 3-6⇨	
●●●●	Any	
☹	Low	
☁	L-N	
wide variety of leaf color and shape; white/yellow, summer flowers; susceptible to pests		



<i>Conocarpus erectus</i> Buttonwood, Silver Buttonwood		
S	10b-11	Yes
	5-50↑ 15-20⇨	
○●●●	Any	
☹	High	
☀ ☁	H	
	🐦	
white/cream, spring flowers; silver leaved form more susceptible to sooty mold and insect problems; do not plant in marl soil; high wind resistance; provides cover for wildlife		



<i>Cordyline</i> spp. & cvs. except <i>Cordyline guineensis</i> Ti plant		
S	10-11	No
Fast	3-10↑ 2-4⇨	
○●●○	Any	
☹☹	Varies	
☀	V	
growing conditions vary by species; flowers vary; cold sensitive; check with your local Extension office before final species selection		

Scientific Common
Reg/Native
G, H, S
Soil pH, Txt
Soil Mst, Drgt
Light/Best Salt
Wildlife



<i>Crataegus</i> spp. Hawthorn
N C 8-9 Var.
20-35↑ 15-40⇒
●●●● Any
High
L-N
provides food and cover for wildlife; flowers vary; best for north Florida; many species and cultivars



<i>Cyrilla racemiflora</i> Titi, Swamp Cyrilla, Leatherwood
N C 8b-9 Yes
Fast 10-30↑ 6-15⇒
●●○○ Any
Medium
L-N
white, late spring through summer flowers; wetland plant; good for edges of retention ponds; attractive to bees



<i>Duranta erecta</i> Golden Dewdrop, Pigeonberry, Skyflower
C S 9b-11 No
4-18↑ 10-15⇒
○○○○ Any
High
L-N
also known as <i>Duranta repens</i> ; showy, lavender/blue/white, summer through fall flowers; poisonous fruit; susceptible to pests; irritating sap; thorns; may spread aggressively



<i>Erythrina herbacea</i> Coral Bean, Cherokee Bean
N C S 8-11 Yes
5-10↑ 8-12⇒
●●○○ S/L
High
M
scarlet, tubular, spring flowers; flowers attractive to hummingbirds; showy, pod-shaped fruit

Scientific Common
Reg/Native
G, H, S
Soil pH, Txt
Soil Mst, Drgt
Light/Best Salt
Wildlife



<i>Eugenia</i> spp. (natives only) Stoppers
C S 9-11 Yes
10-30↑ 5-20⇒
●●●● Any
High
H
flowers vary; needs little attention once established; natives are <i>E. axillaris</i> , <i>E. foetida</i> , <i>E. rhombea</i> , and <i>E.confusa</i> ; <i>E. axillaris</i> , <i>E. confusa</i> , <i>E. foetida</i> have high wind resistance



<i>Fatsia japonica</i> Japanese Aralia, Paperplant
N C S 8-11 No
5-8↑ 3-10⇒
○○○○ Any
Medium
L-N
creamy, white, winter flowers; too much sun eventually kills the plant



<i>Forestiera segregata</i> Florida Privet
N C S 8b-11 Yes
4-15↑ 3-12⇒
○○○○ S/L
High
H
yellow, early spring flowers attract insects; great hedge; fruit provides food for wildlife



<i>Galphimia glauca</i> Thryallis, Rain-of-Gold
C S 9b-11 No
5-9↑ 4-6⇒
○○○○ Any
Medium
L-N
evergreen shrub; yellow, year-round flowers; susceptible to caterpillars and mites

Large Shrubs

Scientific Common
Reg/Native
G, H, S
Soil pH, Txt
Soil Mst, Drgt
Light/Best Salt
Wildlife



<i>Gardenia jasminoides</i> Gardenia, Cape Jasmine
N C S 8-10 No
4-8↑ 4-8⇒
●●○○ Any
☾ Medium
☀ ☁ L-N
also known as <i>Gardenia augusta</i> ; white, fragrant spring through summer flowers; use only grafted varieties due to nematode susceptibility; susceptible to scales; use iron fertilizer to keep green



<i>Halesia diptera</i> Two-wing Silverbell
N 8 Yes
20-30↑ 20-30⇒
●●●○ S/L
☾☾ Medium
☀ ☁ ☁ U
deciduous tree; showy, bell-shaped, white, spring flowers



<i>Hamamelis virginiana</i> Common Witchhazel
N 8 Yes
20-30↑ 15-25⇒
●●●● Any
☾ Medium
☀ ☁ ☁ L-N
cream/yellow, fall flowers; galls form on leaves; plant suckers freely from the base



<i>Hamamelis patens</i> Firebush, Scarletbush
C S 9-11 Yes
Fast 5-20↑ 5-8⇒
●●●● Any
☾☾ Medium
☀ ☁ ☁ L-N
☦ ☦ ☦
orange/red, year-round flowers; susceptible to pests; foliage usually more attractive in shade but flowers best in sun; tolerates occasionally wet soil; dies back in freezes but returns



<i>Schefflera arboricola</i> Dwarf Schefflera
C S 9-11 No
10-15↑ 6-15⇒
○○●○ S/L
☾☾ High
☀ ☁ M
evergreen; dark green foliage; orange/yellow winter fruit; susceptible to scale



<i>Hibiscus</i> spp. Hibiscus, Mallows
N C S 8-11 Yes
4-12↑ 3-10⇒
●●○○ S/L
☾☾ Medium
☀ ☁ V
☦
select species based on site conditions; spring through fall flowers, color varies; some hibiscus injured by freezes in North Florida; susceptible to pests



<i>Hydrangea arborescens</i> Wild Hydrangea
N C 8-9 Yes
6-10↑ 6-10⇒
○○●○ Any
☾☾ None
☁☾ U
deciduous; white, summer flowers; oval, serrate, dark green leaves; blooms on new season's growth; susceptible to disease



<i>Hydrangea macrophylla</i> Hydrangea, Bigleaf Hydrangea, French Hydrangea
N C 8-9a No
6-10↑ 6-10⇒
●●●● Any
☾☾ Medium
☁☾ L-N
white/pink/purple, spring through summer flowers; susceptible to pests; tolerates occasionally wet soil

Scientific Common
Reg/Native
G, H, S
Soil pH, Txt
Soil Mst, Drgt
Light/Best Salt
Wildlife



<i>Hydrangea quercifolia</i> Oakleaf Hydrangea
N C 8b-9 Yes
6-10↑ 6-8⇔
●●●○ Any
☾ Medium
☀ ☁ ☁ L-N
Wildlife
pink, summer flowers; good flowering shrub for shade; tolerates occasionally wet soil



<i>Ilex X'Mary Nell</i> Mary Nell Holly
N C 8-9 Yes
10-20↑ 10-15⇔
●●●○ S/C
☾ Medium
☀ ☁ ☁ M
Wildlife
white, spring flowers; important source of pollen for bees



<i>Ilex cornuta</i> and cvs. Chinese Holly, Horned Holly
N C 8-9 No
15-25↑ 15-25⇔
●●●○ Any
☾ High
☀ ☁ ☁ M
Wildlife
susceptible to tea scale, especially in cool, shady areas; fruit provides food for wildlife; important source of pollen for bees



<i>Ilex vomitoria</i> and cvs. Yaupon Holly
N C S 8-10 Yes
15-30↑ 6-20⇔
●●●○ Any
☾ High
☀ ☁ ☁ H
Wildlife
flammable, in wildfire prone areas, plant minimum 30' from buildings; white, spring through summer flowers; red fruit provides food for wildlife in late fall-winter; 'Pendula' was FNGLA Plant of the Year, 2005; high wind resistance; can sucker to produce a thicket

Scientific Common
Reg/Native
G, H, S
Soil pH, Txt
Soil Mst, Drgt
Light/Best Salt
Wildlife



<i>Illicium</i> spp. Star Anise
N C 8-9 Var.
10-15↑ 6-15⇔
●●●○ Any
☾ Medium
☀ ☁ ☁ L-N
Wildlife
evergreen, yellowish-white or greenish-white flowers



<i>Itea virginica</i> Virginia Willow, Virginia Sweetspire
N C 8-9 Yes
Slow 3-8↑ 2-4⇔
●●●○ S/L
☾ Medium
☀ ☁ ☁ L-N
Wildlife
white, spring through summer flowers; grows well in wet areas such as detention ponds, swales and canals



<i>Jasminum mesnyi</i> Primrose Jasmine, Japanese Yellow Jasmine
N C S 8-10 No
Fast 5-10↑ 2-5⇔
●●●● Any
☾ Medium
☀ ☁ ☁ L-N
Wildlife
rambling, evergreen; will climb like vine if given support; fragrant, yellow flowers; dies back in freeze, may come back



<i>Jasminum multiflorum</i> Downy Jasmine
C S 9b-11 No
Fast 5-10↑ 5-10⇔
●●●● Any
☾ Medium
☀ ☁ ☁ L-N
Wildlife
white, fragrant, year-round flowers; dies back in freeze, may come back; susceptible to pests; sprawling form

Large Shrubs

Scientific Common
Reg/Native
G, H, S
Soil pH, Txt
Soil Mst, Drgt
Light/Best Salt
Wildlife



<i>Jatropha integerrima</i> Peregrina
C S 9b-11 No
8-15↑ 5-10⇒
●●●● Any
High
☀ ☁ L-N
🦋 🦅
scarlet, year-round flowers; poisonous; susceptible to pests and disease; sensitive to frost



<i>Juniperus chinensis</i> and cvs. Chinese Juniper, Japanese Juniper
N C 8-9 No
2-60↑ 2-25⇒
●●●● S
High
☀ M
🐦
flammable, in wildfire prone area, plant minimum 30' from buildings; does not tolerate wet feet; good pollution tolerance; susceptible to pests and disease; size and form vary with cultivar



<i>Ligustrum japonicum</i> and cvs. Ligustrum, Japanese Privet
N C S 8-10b No
8-12↑ 15-25⇒
○●●○ Any
High
☀ ☁ H
white, summer flowers; susceptible to pests and diseases; used as hedge; thins at bottom unless in full sun



<i>Loropetalum chinense</i> and cvs. Loropetalum, Chinese Fringe Bush
N C 8-9 No
6-15↑ 8-10⇒
●●●○ Any
Medium
☀ ☁ L-N
white/pink, spring flowers; size varies; susceptible to pests and diseases; in high pH soils may have minor element deficiencies

Scientific Common
Reg/Native
G, H, S
Soil pH, Txt
Soil Mst, Drgt
Light/Best Salt
Wildlife



<i>Lyonia ferruginea</i> Rusty Lyonia
N C S 8-10 Yes
Slow 10-20↑ 4-10⇒
●●●○ S
High
☀ ☁ L-N
🦋
evergreen, white/pink, spring flowers; rusty pubescence present on all parts of the plant



<i>Mahonia bealei</i> Oregon Hollygrape
N 8-9a No
Slow 5-10↑ 3-4⇒
●●●○ Any
Medium
☀ ☁ M
🐦
also known as <i>Berberis bealei</i> ; yellow, fragrant, winter through spring flowers; glossy grey/green leaves, holly-like appearance; purplish-blue berries provide food for wildlife



<i>Malvaviscus arboreus</i> Turk's cap
N C S 8b-11 No
Fast 6-12↑ 3-5⇒
●●●● Any
Medium
☀ L-N
red/white, warm season flowers; possible cold damage in North Florida

Scientific Common
Reg/Native
G, H, S
Soil pH, Txt
Soil Mst, Drgt
Light/Best Salt
Wildlife



Murraya paniculata
Orange Jessamine, Orange Jasmine, Chalcas

C S 9b-11 No

Slow 8-12↑ 8-15⇔

●●●● Any

High

L-N



white, fragrant, year-round flowers; good container plant; often used as a hedge; provides food for wildlife; susceptible to pests



Musa spp.
Banana

C S 9b-11 No

Fast 7-30↑ 10-15⇔

●●●● Any

Low

L-N

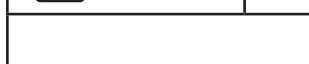

edible fruit; showy purple or orange flowers; needs regular watering; susceptible to disease, pests, and frost



Myrcianthes fragrans
Simpson's Stopper, Twinberry

C S 9b-11 Yes

6-30↑ 15-20⇔

○●●● Any

High

H

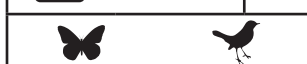

edible fruit; white, fragrant, year-round flowers; red berries provide food for wildlife; tolerates occasionally wet soil; needs little attention once established



Myrica cerifera and cvs.
Wax Myrtle

N C S 8-10 Yes

Fast 10-40↑ 20-25⇔

●●●● Any

Medium

H

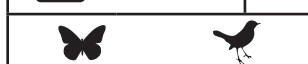

flammable, in wildfire prone areas, plant minimum 30' from buildings; susceptible to disease; good hedge plant; provides food and cover for wildlife; medium to low wind resistance, can sucker to produce a thicket

Scientific Common
Reg/Native
G, H, S
Soil pH, Txt
Soil Mst, Drgt
Light/Best Salt
Wildlife



Nerium oleander
Oleander

N C S 9-11 No

Fast 4-18↑ 3-15⇔

●●●○ Any

High

M



good, low maintenance plant for coastal areas; susceptible to oleander caterpillar; poisonous



Osmanthus americanus
Wild Olive, Devilwood

N C 8b-9 Yes

15-25↑ 10-15⇔

○●●○ Any

Medium

H



white, fragrant, spring flowers; provides food for wildlife



Osmanthus fragrans
Tea Olive, Fragrant Olive, Sweet Osmanthus

N C 8b-9 No

Slow 15-30↑ 15-20⇔

○●●○ Any

Medium

L-N



white, fragrant, fall through spring flowers; susceptible to pests



Pithecellobium keyense
Florida Keys Blackbead

C S 9b-11 Yes

20↑

S

High

H



forms thickets and sandy shores and dry coastal areas; showy, fragrant flowers are an attractive feature

Large Shrubs

Scientific Common
Reg/Native
G, H, S
Soil pH, Txt
Soil Mst, Drgt
Light/Best Salt
Wildlife



<i>Philadelphus inodorus</i> English Dogwood	
N C	8-9a Yes
Fast	10-12↑ 6-10⇒
●●●○	Any
☾☾	High
☀ ☁	U
deciduous; white, spring flowers	



<i>Philodendron bipinnatifidum</i> Selloum, Tree Philodendron	
N C S	8b-11 No
Fast	6-12↑ 10-15⇒
●●●○	Any
☾☾	Medium
☀ ☁	L-N
large, deeply divided, drooping leaves; green, year-round flowers; susceptible to freeze damage; tolerates occasionally wet soil	



<i>Philodendron</i> cvs. Philodendron	
N C S	8b-11 No
Fast	1-12↑ 2-15⇒
●●●○	Any
☾☾	Medium
☀ ☁	L-N
select species based on site conditions; check with your local Extension office before final species selection except <i>Monstera deliciosa</i>	



<i>Pittosporum tobira</i> cvs. Pittosporum	
N C S	8-11 No
	8-12↑ 12-18⇒
●●●○	S/L
☾	High
☀ ☁	H
dark, glossy leaves; white, fragrant, spring flowers	

Scientific Common
Reg/Native
G, H, S
Soil pH, Txt
Soil Mst, Drgt
Light/Best Salt
Wildlife



<i>Podocarpus gracilior</i> Weeping Fern Pine, Weeping Podocarpus, Weeping Yew	
C S	9b-11 No
	30-50↑ 25-35⇒
●●●○	Any
☾	Medium
☀ ☁	L-N
grows slowly in full shade; high wind resistance	



<i>Podocarpus macrophyllum</i> and cvs. Podocarpus	
N C S	8b-11 No
Slow	30-40↑ 20-25⇒
●●●○	S/C
☾	High
☀ ☁	H
dark green, evergreen leaves; small, purple, fruit on females provide food for wildlife; high wind resistance; mildly susceptible to pests and diseases; some magnesium deficiency on sandy soils	



<i>Psychotria nervosa</i> Wild Coffee	
S	10b-11 Yes
	4-10↑ 4-10⇒
●●●○	Any
☾	Medium
☀ ☁	M
🦋 🐦	
shiny, dark green foliage; white, spring through summer flowers; susceptible to pests; red fruit provides food for wildlife	



<i>Rhamnus caroliniana</i> Carolina Buckthorn	
N C	8-9b Yes
	12-15↑ 10-15⇒
●●●○	Any
☾	High
☀ ☁	U
🐦	
bright green, deciduous leaves, turn orange/red before dropping; inconspicuous, green/white, summer flowers; black fruits provide food for wildlife	

Scientific Common
Reg/Native
G, H, S
Soil pH, Txt
Soil Mst, Drgt
Light/Best Salt
Wildlife



<i>Rhododendron austrinum</i> Florida Flame Azalea
N C 8-9 Yes
Slow 6-10↑ 4-8⇒
●●○○ Any
☾ Medium
☀ L-N
🦋 🐦 🐦
yellow/orange, clustered spring flowers



<i>Rhododendron canescens</i> Pinxter Azalea
N C S 8-10a Yes
Slow 8-12↑ 6-10⇒
●●○○ Any
☾ Medium
☀ L-N
🦋 🐦 🐦
pink/white, spring flowers; prefers well drained soil that retains moisture



<i>Rhododendron</i> cvs. Azalea
N C 8-10 Var.
Slow 3-12↑ 3-10⇒
●●○○ Any
☾ Medium
☀ L-N
🦋 🐦 🐦
choose species based on site conditions; flowers vary



<i>Sabal minor</i> Dwarf Palmetto, Blue-stem Palmetto
N C S 8-11 Yes
Slow 4-9↑ 4-8⇒
●●●● Any
☾ High
☀ ☀ ☀ M
🦋 🐦
bluish green, fan shaped leaves; small, white flowers; black berries provide food for wildlife in fall; difficult to transplant; good understory plant; prefers moist soils but tolerates drier conditions after establishment

Scientific Common
Reg/Native
G, H, S
Soil pH, Txt
Soil Mst, Drgt
Light/Best Salt
Wildlife



<i>Senna alata</i> Candlestick Plant
S 10a-11 No
Fast 10-15↑ 10-15⇒
●●●○ Any
☾ Medium
☀ U
🦋
plant grows rapidly in full sun; prune harshly in the spring for a larger flower display in the next year



<i>Senna bicapsularis</i> Christmas Senna, Butterfly Bush
N C S 8-11 No
Fast 6-12↑ 6-12⇒
●●●● Any
☾ Medium
☀ L-N
🦋
susceptible to freeze damage and pests; susceptible to caterpillar damage; larval food plant for various sulphur butterflies; should not be confused with <i>Senna pendula</i>



<i>Senna polyphylla</i> Desert Cassia
S 10a-11 No
6-10↑ 6-8⇒
○●●● S/L
☾ Medium
☀ ☀ H
🦋
yellow, summer flowers; should not be confused with <i>Senna pendula</i>



<i>Severinia buxifolia</i> Boxthorn
N C S 8b-10 Yes
Slow 5-12↑ 3-6⇒
●●●○ Any
☾ High
☀ ☀ L-N
🦋
dense, low-branching, compact, evergreen; small, oval, glossy, dark green leaves; slender, thorny branches; small, fragrant, white, spring through summer flowers; susceptible to freeze damage

Large Shrubs

Scientific Common
Reg/Native
G, H, S
Soil pH, Txt
Soil Mst, Drgt
Light/Best Salt
Wildlife



<i>Strelitzia nicolai</i> Giant Bird of Paradise, White Bird of Paradise	
C S	9-11 No
Fast	20-30↑ 15-20⇒
●●●○	Any
☾	Low
☀ ☁	L-N
	
<p>large, banana-like leaves, blue/white, year-round flowers; susceptible to scales when air circulation is inadequate; foliage may tear in the wind</p>	



<i>Suriana maritima</i> Bay Cedar	
S	10b-11 Yes
	5-20↑ 5-8⇒
●●●●	S/L
☾	High
☀ ☁	H
	
<p>evergreen, tiny, gray/green leaves; yellow, year-round flowers; commonly found growing in thickets, on sand dunes, and rocky shores</p>	



<i>Tabernaemontana divaricata</i> Crape Jasmine, Pinwheel Flower	
C S	9b-11 No
Fast	6-10↑ 3-6⇒
●●●●	Any
☾	Low
☀ ☁	L-N
	
<p>evergreen, white, ruffle-edged, summer flowers that are fragrant at night; susceptible to pests and diseases</p>	



<i>Ternstroemia gymnanthera</i> Cleyera, Ternstroemia	
N C	8-9 No
	12-20↑ 5-10⇒
○●●○	Any
☾	Medium
☀ ☁	L-N
	
<p>dense, unusually dark green foliage; yellow to dark red fruit; white, fragrant, spring flowers; good as a hedge</p>	

Scientific Common
Reg/Native
G, H, S
Soil pH, Txt
Soil Mst, Drgt
Light/Best Salt
Wildlife





<i>Thunbergia erecta</i> King's Mantle, Bush Clock Vine	
C S	9-11 No
Fast	4-6↑ 5-8⇒
●●●●	Any
☾	Medium
☀ ☁	L-N
	
<p>purple, year-round flowers; good as a hedge</p>	



<i>Tibouchina granulosa</i> Purple Glory Tree	
S	10b-11 No
Fast	15-20↑ 15-20⇒
●●○○	S/L
☾	Medium
☀	U
	
<p>evergreen; dark green, velvety leaves; purple, year-round flowers</p>	



<i>Vaccinium arboreum</i> Sparkleberry	
N C	8-10b Yes
	12-18↑ 10-15⇒
●●○○	Any
☾	Medium
☀ ☁	L-N
 	
<p>deciduous; white, spring flowers; showy fall color; tolerates occasionally wet soil; provides food and cover for wildlife; attracts pollinating insects</p>	

Scientific Common
Reg/Native
G, H, S
Soil pH, Txt
Soil Mst, Drgt
Light/Best Salt
Wildlife



<i>Viburnum obovatum</i> and cvs. Walter's Viburnum
N C S 8-10 Yes
8-25↑ 6-10⇒
●●●● Any
High
L-N
Wildlife
white, winter through spring flowers; small black fruit provides food for wildlife; provides nesting cover for wildlife; can sucker to produce a thicket; dwarf cvs. are 2' to 4' tall



<i>Viburnum odoratissimum</i> Sweet Viburnum
N C S 8b-10a No
15-30↑ 15-25⇒
●●●● Any
Medium
L-N
Wildlife
white, spring flowers; susceptible to pests and disease; often grown as a hedge; thins in shaded sites



<i>Viburnum odoratissimum</i> var. <i>awabuki</i> Awabuki Viburnum
N C S 8-10b No
Slow 15-20↑ 15-20⇒
●●●○ Any
Medium
L-N
Wildlife
also known as <i>Viburnum awabuki</i> ; fragrant, small white, spring flowers; red/black fruit provides food for wildlife; takes well to pruning; used for hedges; susceptible to pests and disease



<i>Viburnum rufidulum</i> Rusty Blackhaw, Southern Blackhaw
N C 8b-9 Yes
Slow 20-25↑ 20-25⇒
●●●● Any
High
H
Wildlife
scarlet to purple fall foliage; clusters of small, white, spring flowers; small black fruit provides food for wildlife; tolerates occasionally wet soil; does not tolerate compacted soils

Scientific Common
Reg/Native
G, H, S
Soil pH, Txt
Soil Mst, Drgt
Light/Best Salt
Wildlife



<i>Viburnum suspensum</i> Sandankwa Viburnum
N C S 8-10 No
6-12↑ 6-12⇒
●●●● Any
Low
M
Wildlife
pink/white, winter through spring flowers



<i>Vitex agnus-castus</i> Chaste Tree
N C S 8-11 No
Fast 10-20↑ 15-20⇒
○●●○ Any
High
M
Wildlife
deciduous; multi-stemmed shrub; purple, summer flowers provides food for wildlife



<i>Yucca</i> spp. Yucca
N C S 8-11 Var.
3-30↑ 3-15⇒
●●●○ Any
High
Var
Wildlife
choose species based on site conditions; white, spring through summer flowers

Small Shrubs

Scientific Common
Reg/Native
G, H, S
Soil pH, Txt
Soil Mst, Drgt
Light/Best Salt
Wildlife



<i>Aloe</i> spp. Aloe	
N C S	8-11 No
1-3↑ 1-3⇔	
●●●●	Any
☾	High
☀ ☁	H
choose species based on site conditions; flowers vary; susceptible to freeze damage	



<i>Acalypha hispida</i> Chenille Plant, Red-hot Cattail	
C S	10-11 No
Fast	4-6↑ 6-8⇔
●●●●	Any
☾	Medium
☀ ☁	L-N
upright, course-textured shrub; red, showy flowers during warm months droop in cattail-like, pendant clusters up to 18 inches in length; susceptible to pests especially in partial shade	



<i>Breynia disticha</i> Snowbush	
C S	10-11 Yes
	5-8↑ 4-7⇔
●●●●	S/L
☾	Medium
☀ ☁	L-N
slender, red branches with variegated foliage; good specimen or accent shrub; red berries; susceptible to pests	



<i>Brunfelsia americana</i> Lady of the Night	
S	9b-11 No
	4-6↑ 3-4⇔
○●●○	Any
☾	High
☀ ☁	L-N
evergreen; fragrant, white flowers	



<i>Caesalpinia</i> spp. and cvs. Poinciana	
C S	9-11 No
	8-35↑ 10-35⇔
○●●○	S/L
☾	Medium
☀	M
choose species adapted to region; do not confuse with <i>Delonix regia</i> ; flowers vary	



<i>Calliandra emarginata</i> Pink Powderpuff	
C S	10-11 No
	6-10↑ 10-15⇔
○●●○	Any
☾	High
☀ ☁	L-N
red/pink, spring through fall flowers	



<i>Carissa macrocarpa</i> Natal Plum	
C S	9-11 No
	2-20↑ 2-20⇔
○●●●	Any
☾	High
☀ ☁	H
also known as <i>Carissa grandiflora</i> ; edible fruit; white, fragrant year-round flowers	



<i>Gamolepis</i> spp. Bush Daisy	
N C S	8b-11 No
	2-4↑ 3-4⇔
○●●○	Any
☾	Medium
☀	L-N
finely-divided leaves with fern-like appearance; yellow, year-round flowers	

Scientific Common
Reg/Native
G, H, S
Soil pH, Txt
Soil Mst, Drgt
Light/Best Salt
Wildlife

Scientific Common
Reg/Native
G, H, S
Soil pH, Txt
Soil Mst, Drgt
Light/Best Salt
Wildlife



<i>Ixora coccinea</i> Ixora
C S 9b-11 No
10-15↑ 4-10⇒
●○○○ Any
☾☾ Medium
☀ L-N
Wildlife
dark green, glossy leaves; colorful year-round flowers



<i>Lantana depressa</i> Weeping Lantana, Pineland Lantana
N C S 8-11 Yes
Fast 3-6↑ 3-6⇒
○○○○ S/L
☾ Medium
☀ H
Wildlife
small, yellow, year-round flowers; susceptible to pests; berries are poisonous



<i>Leucophyllum frutescens</i> Texas Sage, Texas Ranger, Silverleaf, Barometer Bush
N C 8b-10a No
3-5↑ 3-5⇒
○○○○ S
☾ High
☀ M
Wildlife
semi-evergreen shrub; white/pink/lavender/blue flowers after summer rains; prefers dry, hot sites; doesn't like fertilizer or compost



<i>Lycium carolinianum</i> Christmas Berry
N C S 7b-11 Yes
4-8↑ 3-6⇒
●●●● C/L
☾☾☾
☀☁ M
Wildlife
wide range of cultivation for plant- tolerates drought and salt spray as well as extended floodings; suckers form at the base of trunks; plant has winter interest due to unusual form, persistent fruits, showy winter trunk, or winter flowers

Scientific Common
Reg/Native
G, H, S
Soil pH, Txt
Soil Mst, Drgt
Light/Best Salt
Wildlife



<i>Lyonia lucida</i> Fetterbush, Shiny Lyonia
N C 8-9 Yes
3-15↑ 2-5⇒
●●○○ S/L
☾☾ High
☀☁ L-N
Wildlife
evergreen; white/pink spring flowers; leaf spotting may occur



<i>Mahonia fortunei</i> Fortune's Mahonia, Chinese Mahonia, Holly Grape
N 8b-9 No
Slow 3-5↑ 3-5⇒
●●○○ Any
☾ Medium
☀☁ M
Wildlife
also known as <i>Berberis fortunei</i> ; yellow year-round flowers; well suited as foundation plant on north or east side of a building



<i>Malpighia coccigera</i> Miniature Holly
S 10b-11 No
Slow 2-5↑ 4-6⇒
●●●● Any
☾ Medium
☀☁ M
Wildlife
pink, spring through summer flowers; red berries; sensitive to pests



<i>Pyracantha coccinea</i> Firethorn
N C 8-9 No
10-15↑ 8-12⇒
●●○○ Any
☾☾ Medium
☀☁ L-N
Wildlife
white, showy flowers; red/orange fall and winter fruit; works well as freestanding specimen plant; can be espaliered or trained onto a trellis; susceptible to pests and diseases

Small Shrubs

Scientific Common
Reg/Native
G, H, S
Soil pH, Txt
Soil Mst, Drgt
Light/Best Salt
Wildlife



<i>Raphiolepis</i> spp. and cvs. Indian Hawthorn
N C 8-9 No
2-10↑ 2-6⇒
○●●○ Any
High
☀ ☁ M
flowers vary; provides food for wildlife; use disease-resistant cvs., plant in full sun; susceptible to disease



<i>Rosa</i> spp. Rose
N C S 8-11 Var.
Fast 1-20↑ 2-8⇒
●●●● Any
Medium
☀ M
flowers vary; susceptible to pests and diseases



<i>Rosmarinus</i> spp. Rosemary
N C S 8-11 No
3-6↑ 4-5⇒
○●●○ S/L
High
☀ ☁ M
evergreen herb with aromatic needle-like leaves; flowers vary



<i>Russelia equisetiformis</i> Firecracker Plant, Coral Plant
C S 9b-11 No
3-5↑ 6-12⇒
○●●○ Any
High
☀ M
multi-branched shrub; rush-like stems; red year-round flowers; susceptible to pests



<i>Russelia sarmentosa</i> Firecracker Plant
N C S 8b-11 No
Fast 3-4↑ 2-4⇒
○●●○ S/L
Medium
☀ ☁ U
red, summer flowers; provides food for wildlife



<i>Sabal etonia</i> Scrub Palmetto
C S 9-11 Yes
Slow 4-6↑ 4-6⇒
●●●● S/L
High
☀ ☁ M
small, white, spring through summer flowers; small, black berries in summer through fall provide food for wildlife; long-lived; difficult to transplant



<i>Spiraea</i> spp. Reeve's Spirea, Bridal Wreath
N C 8-9 No
3-5↑ 3-4⇒
○●●○ Any
Medium
☀ ☁ L-N
deciduous; white, spring flowers; check with your local Extension office before final species selection



<i>Strelitzia reginae</i> Bird of Paradise
S 10-11 No
3-5↑ 2-4⇒
●●●○ Any
High
☀ ☁ L-N
large leathery leaves are held upright on stiff stalks; orange/blue striking flowers; susceptible to pests; tolerates occasionally wet soil

Scientific Common
Reg/Native
G, H, S
Soil pH, Txt
Soil Mst, Drgt
Light/Best Salt
Wildlife

NOTES

A series of horizontal dotted lines providing a template for notes.

Vines

Scientific Common
Reg/Native
G, H, S
Soil pH, Txt
Soil Mst, Drgt
Light/Best Salt
Wildlife



<i>Aristolochia</i> spp. Dutchman's Pipe, Pipevine
C S 9-10 Var.
Fast 10-15↑ 10-15⇒
○○○○○ S
☹ Medium
☀ ☁ ☁ L-N
🦋
tender evergreen vine; white/purple, summer through winter flowers; larval food plant for several swallowtail butterflies ; except <i>Aristolochia littoralis</i>



<i>Aster carolinianus</i> Climbing Aster
N C S 8-10b Yes
1-12↑ 2-4⇒
○○○○○ Any
☹☹☹ Medium
☀ ☁ ☁ L-N
🦋 🐦
also known as <i>Ampelaster carolinianus</i> , <i>Symphyotricum carolinianum</i> ; lavender, fall flowersx



<i>Bignonia capreolata</i> Cross Vine, Trumpet Flower
N C S 8-10 Yes
Fast 1-50↑ 1-50⇒
●●●○○ Any
☹☹ High
☀ ☀ ☁ M
🦋
fast-growing, high-climbing vine; orange/red, trumpet-shaped, spring flowers



<i>Bougainvillea</i> cvs. Bougainvillea
C S 9b-11 No
Fast 4-40↑ 15-40⇒
●●●○○ S/L
☹ High
☀ ☁ M
evergreen, shrubby vine; pink/yellow/orange, year-round flowers; large spines; susceptible to freeze damage

Scientific Common
Reg/Native
G, H, S
Soil pH, Txt
Soil Mst, Drgt
Light/Best Salt
Wildlife



<i>Campsis radicans</i> Trumpet Creeper, Trumpet Vine
N C S 8-10a Yes
Fast 1-40↑ 1-40⇒
●●●●● Any
☹ Medium
☀ ☁ ☁ L-N
🦋 🦋
brilliant orange, summer flowers



<i>Decumaria barbara</i> Climbing Hydrangea, Wood Vamp, Cow Itch Vine
N C 8-9a Yes
1-60↑ 1-60⇒
●●○○○ S/L
☹☹ Medium
☀ ☁ L-N
white, spring flowers



<i>Gelsemium sempervirens</i> Carolina Jessamine, Yellow Jasmine
N C 8-9 Yes
Fast 20-40↑ 20-30⇒
●●●○○ Any
☹☹ Low
☀ ☁ L-N
🦋
evergreen; yellow, tubular, winter through spring flowers; rapid growth when established; poisonous

Scientific Common
Reg/Native
G, H, S
Soil pH, Txt
Soil Mst, Drgt
Light/Best Salt
Wildlife



<i>Ipomoea</i> spp. (natives only) Morning Glory
N C S 8-11 Yes
Fast 10-20↑ 10-40⇒
○●●○ Any
High
M
flower color varies; can spread easily; provides food for wildlife; except for <i>Ipomoea cairica</i>



<i>Ipomoea pes-caprae</i> Railroad Vine
S 10b-11 Yes
Fast
●●●● S/L
High
H
aggressive, spreading plant great for dune stabilization



<i>Jasminum multiflorum</i> Downy Jasmine
C S 9b-11 No
Fast 5-10↑ 5-10⇒
●●●● Any
Medium
L-N
white, fragrant, year-round flowers; dies back in freeze, may come back; susceptible to pests; sprawling form



<i>Lonicera sempervirens</i> Honeysuckle, Coral Honeysuckle
N C 8-9 Yes
Fast 10-15↑ 10-15⇒
●●●○ Any
Medium
M
dark green, smooth leaves; red, spring through summer flowers; fruit provides food for wildlife; susceptible to freeze damage

Scientific Common
Reg/Native
G, H, S
Soil pH, Txt
Soil Mst, Drgt
Light/Best Salt
Wildlife



<i>Mandevilla</i> cvs. Pink Allamanda, Mandevilla
C S 9b-11 No
1-10↑ 1-10⇒
○●●○ Any
Medium
L-N
twining evergreen vine; many cultivars; pink/white, year-round flowers



<i>Millettia reticulata</i> Evergreen Wisteria
C S 9-11 No
Fast 12-15↑ 10-12⇒
○●●○ S/L
Low
M
deciduous in North Florida; glossy, leathery textured leaves; purple, summer through fall flowers



Vines

Scientific Common
Reg/Native
G, H, S
Soil pH, Txt
Soil Mst, Drgt
Light/Best Salt
Wildlife



<i>Pandorea jasminoides</i> Bower Vine	
C S	9b-11 No
Fast	1-20↑ 1-20⇒
●●●○	Any
☾	Medium
☀ ☁	L-N
	
evergreen; maintains an open, fine-textured effect; 2 inch wide, white, pink-throated, summer through winter flowers	



<i>Passiflora incarnata</i> Maypop, Passion Vine	
N C S	8b-11 Yes
Fast	5-10↑ 5-10⇒
●●●●	Any
☾	High
☀ ☁	M
 	
evergreen; pink/purple, summer through fall flowers; larval food plant of zebra longwing, gulf fritillary, and variegated fritillary butterflies; tolerates occasionally wet soil	



<i>Passiflora 'Lady Margaret'</i> Lady Margaret Passionflower	
N C S	7-10 No
Fast	3-12↑ 3-12⇒
○●●○	Any
☾	
☀ ☁	M
	
plant has potential to sprawl throughout the garden due to its fast growth rate; sends out underground stems, producing plants that are far from mother plant	



<i>Petrea volubilis</i> Queen's Wreath	
S	10b-11 No
Fast	30-40↑ 30-40⇒
○●●●	Any
☾	Medium
☀ ☁	L-N
	
evergreen; purple, spring flowers	

Scientific Common
Reg/Native
G, H, S
Soil pH, Txt
Soil Mst, Drgt
Light/Best Salt
Wildlife



<i>Combretum indicum</i> Rangoon Creeper	
S	10a-11 No
Fast	1-40↑ 1-40⇒
●●●○	Any
☾	Medium
☀ ☁	L-N
1" flowers turn from white to pink or pink to deep red, blooms in spring through fall; good for fences, pergolas, and small buildings; susceptible to pests	



<i>Thunbergia alata</i> Black-Eyed Susan Vine	
N C S	8-11 No
Fast	5-10↑ 5-10⇒
○●●○	S/L
☾	Low
☀ ☁	L-N
perennial; yellow, summer flowers	



<i>Trachelospermum jasminoides</i> Confederate Jasmine, Star Jasmine	
N C S	8-10 No
Fast	1-40↑ 1-40⇒
●●●●	Any
☾	Medium
☀ ☁	L-N
	
white, fragrant, showy, spring flowers; susceptible to diseases	



<i>Wisteria frutescens</i> American Wisteria	
N C	8-9 Yes
Fast	10-20↑ 6-12⇒
○●●○	Any
☾	Medium
☀ ☁	L-N
	
lavender, fragrant, spring through summer flowers; poisonous parts	

NOTES

Groundcovers

Scientific Common
Reg/Native
G, H, S
Soil pH, Txt
Soil Mst, Drgt
Light/Best Salt
Wildlife



<i>Anthericum sanderi</i> St. Bernard's Lily	
N C S	8-11 No
Fast	1-1½↑ ½-1⇌
○●●○	Any
☾	Medium
☀ ☁	U
white, spring flowers	



<i>Arachis glabrata</i> Perennial Peanut	
N C S	8-11 No
Slow	½-1↑ 1-8⇌
○●●○	S
☾	High
☀	H
🦋	
yellow/orange, summer through fall flowers; no nitrogen fertilizer needed; may spread aggressively; with-stands foot traffic; damaged by frost in North and Central Florida	



<i>Aspidistra elatior</i> Cast Iron Plant, Barroom Plant	
N C S	8b-11 No
Slow	1-3↑ 1-3⇌
○●●○	Any
☾	Medium
☀ ☁	L-N
dark, green, glossy foliage; brown flowers periodically throughout the year; tolerates deep shade better than most plants	



<i>Cephalotaxus harringtonia</i> 'Prostrata' Creeping Yew	
N C	6-9 No
Slow	1-2↑ 3-6⇌
○●○○	Any
☾	High
☀ ☁	L-N
plant has dark green, needle-like leaves; deer won't usually eat it	



<i>Cyrtomium falcatum</i> Holly Fern	
N C S	8b-11 No
	2-3↑ 3-4⇌
○●●○	Any
☾ ☾	Medium
☀ ☀ ☁	L-N
evergreen fern; good low-maintenance groundcover; susceptible to pests	



<i>Dryopteris</i> spp. Autumn Fern	
N C S	8-11 Var.
Slow	1-4↑ 1-4⇌
●●○○	Any
☾	Medium
☀ ☁	L-N
dark green fern with delicate appearance; fronds appear reddish when young; choose species based on growing conditions	

Scientific Common
Reg/Native
G, H, S
Soil pH, Txt
Soil Mst, Drgt
Light/Best Salt
Wildlife

Scientific Common
Reg/Native
G, H, S
Soil pH, Txt
Soil Mst, Drgt
Light/Best Salt
Wildlife



<i>Dyschoriste oblongifolia</i> Twin Flower, Oblongleaf Snakeherb
N C S 8-11 Yes
Fast ½-1↑ 1-1½⇒
○○●○○ Any
High
L-N
lavender, year-round flowers; commonly used as ground-cover; larval food plant for common Buckeye



<i>Ernodea littoralis</i> Golden creeper
S 10-11 Yes
1-3↑ 1-3⇒
●●●○○ S/C
High
H
small, light green, succulent leaves on bright red stems; inconspicuous, pinkish, tubular flowers; golden berries; will die if overwatered



<i>Evolvulus glomeratus</i> Blue Daze
C S 9-11 No
½-1↑ 1-2⇒
○○●○○ Any
Medium
H
creates grey/green carpet-like cover accented with sky blue, spring through summer flowers



<i>Glandularia tampensis</i> Tampa Vervain, Tampa Mock Vervain
C S 9-11 Yes
1½-2↑ 1-1½⇒
○○●○○ S
High
L-N
also known as <i>Verbena tampensis</i> ; purplish-pink/white, summer flowers

Scientific Common
Reg/Native
G, H, S
Soil pH, Txt
Soil Mst, Drgt
Light/Best Salt
Wildlife



<i>Ipomoea</i> spp. (natives only) Sweet Potato Vine, Railroad Vine
N C S 8-11 Yes
Fast 10-20↑ 10-40⇒
○○●○○ Any
High
M
flower color varies; can spread easily; provides food for wildlife



<i>Juniperus conferta</i> and cvs. Shore Juniper
N C 8-9 No
Slow 1-2↑ 6-10⇒
●●●●○ S
High
H
flammable - in wildfire prone areas, plant minimum 30' from buildings; must be in full sun and well drained soils; used for dune stabilization; susceptible to diseases

Groundcovers

Scientific Common
Reg/Native
G, H, S
Soil pH, Txt
Soil Mst, Drgt
Light/Best Salt
Wildlife



<i>Juniperus horizontalis</i> and cvs. Creeping Juniper, Horizontal Juniper	
N C	8a-9a No
	½-1↑ 8-10⇒
●●●●	Any
☾	High
☀ ☁	M
🐦	
plants become thin in partial shade; does not tolerate waterlogged conditions; susceptible to pests and diseases	



<i>Mimosa strigillosa</i> Powderpuff, Sunshine Mimosa	
N C S	8-11 Yes
Fast	½-¾↑ 8-10⇒
●●●○	Any
☾	Medium
☀ ☁	M
🦋	
perennial; pink powderpuff flowers; FNGLA Plant of the Year	



<i>Nephrolepis biserrata</i> Giant Sword Fern	
C S	9-11 Yes
	1-4↑ 1-4⇒
○●○○	C/L
☾	Medium
☀ ☁	L-N
should not be confused with the exotic invasive fern <i>Nephrolepis cordifolia</i> ; may spread beyond small gardens and become difficult to control; looks best in full shade	



<i>Nephrolepis exaltata</i> Sword Fern	
C S	9-11 Yes
	1-4↑ 1-4⇒
○○○○	Any
☾	Medium
☀ ☁	L-N
should not be confused with the exotic invasive fern <i>Nephrolepis cordifolia</i> ; may spread beyond small gardens and become difficult to control; looks best in full shade	



<i>Ophiopogon japonicus</i> and cvs. Mondo Grass, Dwarf Lilyturf, Dwarf Liriopoe	
N C S	8-11 No
Slow	½-1↑ ½-2⇒
○○●○	Any
☾	Medium
☀ ☁	M
white, summer flowers; dark green, grass-like mounds; tolerates some foot traffic	



<i>Phlox subulata</i> Creeping Phlox	
N C S	3b-10 No
	½-1↑
●●●●	Any
☾	Medium
☀ ☁	L-N
aggressive groundcover; mass spring flowering; attractive plant	



<i>Phyla nodiflora</i> Turkey Tangle Fogfruit, Capweed	
N C S	8-11 Yes
	½-1↑ 8-10⇒
●●●●	Any
☾ ☾	Medium
☀ ☁	L-N
🦋	
small, purplish-white flowers; may appear dormant in drought but comes back; occasional mowing improves appearance; excellent butterfly attractor; can become weedy; larval food plant	

Scientific Common
Reg/Native
G, H, S
Soil pH, Txt
Soil Mst, Drgt
Light/Best Salt
Wildlife



Rumohra adiantiformis
Leatherleaf Fern,
Seven Weeks Fern

C	S	9b-11	No
1-3↑	4-5⇒		
○○○○	Any		
☾	Medium		
☀ ☁	L-N		

evergreen fern with triangular-shaped, dark glossy green leaflets



Scaevola plumieri
Inkberry

S	10-11	Yes
Slow	2-4↑	3-8⇒
●●●●	S/L	
☾	High	
☀	H	

small, pink/white, summer flowers; spreads by underground rhizomes; suited for coastal areas



Thelypteris kunthii
Southern Shield Fern

N	C	S	8-11	Yes
Fast	2-3↑	2-4⇒		
○○○○	Any			
☾	Medium			
☀ ☁ ☁	L-N			

robust fern with graceful light green foliage; may spread beyond small gardens and become difficult to control



Trachelospermum asiaticum
Small-Leaf Confederate Jasmine, Asiatic Jasmine

N	C	S	8b-10	No
Fast	1-3↑	1-30⇒		
●●●●	Any			
☾	Medium			
☀ ☁	M			

small, dark green glossy leaves, prominent light green veins; tolerates foot traffic; spreads aggressively; susceptible to pests, diseases and cold damage in low 20's

Scientific Common
Reg/Native
G, H, S
Soil pH, Txt
Soil Mst, Drgt
Light/Best Salt
Wildlife



Trachelospermum jasminoides
Confederate Jasmine,
Star Jasmine

N	C	S	8b-10	No
Fast	1-3↑	1-30⇒		
●●●●	Any			
☾	Medium			
☀ ☁	L-N			
🐦				

white, fragrant, showy, spring flowers; susceptible to diseases



Zamia floridana
Coontie, Florida Arrowroot,
Florida Zamia

N	C	S	8b-11	Yes
Slow	1-5↑	3-5⇒		
●●●●	Any			
☾	High			
☀ ☁ ☁	H			
🦋				

small palm-like perennial plant; Florida's only native cycad; sole larval food plant for atala butterfly; susceptible to pests and cold damage in the 20's



Zamia furfuracea
Cardboard Plant

C	S	9b-11	No
Slow	2-5↑	5-8⇒	
●●●●	Any		
☾	High		
☀ ☁ ☁	H		

seeds and caudex poisonous; freezes in central Florida and can come back; caution - may be invasive in South and Central Florida

Grasses

Scientific Common
Reg/Native
G, H, S
Soil pH, Txt
Soil Mst, Drgt
Light/Best Salt
Wildlife



<i>Andropogon</i> spp. Bluestem Grass		
N C	8-9	Var.
Fast	3-10↑ 3-7⇔	
●●●●	Any	
☾	High	
☀		H
perennial bunch grass; species need vary; check with Extension office before making final selection; silver/white/pink, fall flowers		



<i>Aristida stricta</i> var. <i>beyrichiana</i> Wiregrass		
N C S	8-11	Yes
Fast	2-4↑ 2-3⇔	
●●○○	S	
☾	High	
☀ ☁		L-N
also known as <i>Aristida beyrichiana</i> ; tan, year-round flowers; provides food and cover for wildlife; depends on regular summer burning to stimulate flowering and seed production		



<i>Cymbopogon citratus</i> Lemongrass		
S	10-11	No
Fast	4-6↑ 4-6⇔	
●●●○	Any	
☾	Medium	
☀ ☁		U
scented leaves remain green most of the year, turning dark red in fall and winter; dies to the ground in winter in North Florida		



<i>Chasmanthium latifolium</i> River Oats, Northern Sea Oats, Indian Wood-oats		
N	8-9a	Yes
Fast	2-5↑ 2-4⇔	
●●○○	Any	
☾	Medium	
☀ ☁		L-N
fall color; tan/bronze, summer through fall flowers; larval food plant for Gemmed Satyr butterfly		

Scientific Common
Reg/Native
G, H, S
Soil pH, Txt
Soil Mst, Drgt
Light/Best Salt
Wildlife



<i>Distichlis spicata</i> Salt Grass		
N C S	8-11	Yes
Slow	1-2↑ 2-4⇔	
○○●●	Any	
☾	Low	
☀		H
tough, scaly rhizomes and rigid stems; few seeds are produced; reproduction is mostly from rhizomes		



<i>Eragrostis elliottii</i> Elliott's Lovegrass		
N C S	8-10	Yes
Fast	1-3↑ 1-3⇔	
●●●○	S/L	
☾	High	
☀ ☁		L-N
tan, year-round flowers, especially in fall		



<i>Eragrostis spectabilis</i> Purple Lovegrass		
N C S	8-10	Yes
Fast	1-3↑ 1-3⇔	
●●●○	S/L	
☾	High	
☀ ☁		L-N
small, red/purple, year-round flowers, especially in fall; grows best in hot, dry sites		



<i>Miscanthus sinensis</i> Zebra Grass, Eulalia Grass		
N C S	8-11	No
	1-9↑ 3-5⇔	
●●●○	Any	
☾	Medium	
☀ ☁		H
dies to the ground in winter in North Florida; excellent specimen plant; susceptible to pests and disease		

Scientific Common
Reg/Native
G, H, S
Soil pH, Txt
Soil Mst, Drgt
Light/Best Salt
Wildlife



<i>Muhlenbergia capillaris</i> Muhly Grass
N C S 8-11 Yes
2-5↑ 2-3⇔
○●●●● S
High
☀️ H
pink, fall flowers; tolerates extreme drought and flooding



<i>Panicum virgatum</i> and cvs. Panic Grass
N C S 8-10 Yes
Fast 1-5↑ 1-5⇔
●●●●○ Any
High
☀️ ☁️ H
tan, summer flowers



<i>Pennisetum setaceum</i> 'Rubrum' Purple Fountain Grass
C S 9-11 No
Fast 4-6↑ 2-4⇔
●●●●○ Any
Medium
☀️ U
valuable accent plant for its showy coloration; lovely when planted in mass and is a nice accent in a border; plant can reseed itself

Scientific Common
Reg/Native
G, H, S
Soil pH, Txt
Soil Mst, Drgt
Light/Best Salt
Wildlife



<i>Schizachyrium scoparium</i> Little Blue Stem Grass
N C 8-9 Yes
1-3↑ 1-3⇔
○●●●○ Any
High
☀️ ☁️ U
🦋 🐦
medium-sized bunchgrass; lavender/blue stem; good for restoring damaged wildland recreation areas; provides food and cover for wildlife



<i>Spartina</i> spp. Cordgrass
N C 8-9 Var.
Fast 3-4↑ 3-5⇔
●●●●○ S
High
☀️ H
marsh grass; fine-textured, wire leaves form a fountain pattern; tan, summer flowers; species needs vary, choose based on site conditions; check with your local Extension office prior to species selection



<i>Tripsacum dactyloides</i> and cvs. Fakahatchee Grass, Gamma Grass
N C S 8-11 Yes
4-6↑ 4-6⇔
●●●●○ Any
Medium
☀️ ☁️ M
🦋
cream/orange/red/yellow, spring through summer flowers; tolerates flooding and standing water; larval food plant for Byssus Skipper butterfly



<i>Tripsacum floridana</i> Florida Gama Grass
N C S 8-11 Yes
2-4↑ 4-6⇔
●●●●○ Any
Medium
☀️ ☁️ M
yellow, spring through summer flowers; used to control erosion; good plant for detention ponds, swales and canal banks

Palms & Palm-Like Plants

Scientific Common
Reg/Native
G, H, S
Soil pH, Txt
Soil Mst, Drgt
Light/Best Salt
Wildlife



<i>Acoelorrhaphe wrightii</i> Paurotis Palm, Saw Cabbage Palm	
S	10-11 Yes
Slow	15-30↑ 10-15⇒
○○●○	Any
☾☾	Medium
☀ ☁ ☁	M
yellow/white, spring flowers; forms dense clump so provide plenty of space; susceptible to manganese deficiency; tolerates occasionally wet soil	



<i>Arenga engleri</i> Formosa Palm, Dwarf Sugar Palm	
C S	9a-11 No
Slow	8-10↑ 12-16⇒
○○●○	Any
☾	None
☀ ☁ ☁	L-N
dark, olive-green leaves often twist, giving a slight spiraling appearance; red/orange/green, spring flowers; red to deep purple fruit	



<i>Bismarckia nobilis</i> Bismarck Palm	
S	10a-11 No
	40-70↑ 15-20⇒
○○●○	Any
☾	High
☀ ☁ ☁	M
stiff, waxy, blue- green fronds; white/cream flowers	



<i>Butia capitata</i> Pindo Palm, Jelly Palm	
N C S	8b-11 No
Slow	15-25↑ 10-15⇒
○○●○	Any
☾	High
☀ ☁ ☁	M
edible fruit used for jelly; provides food for wildlife; looks best in full sun; white flowers; susceptible to pests; high wind resistance	



<i>Carpentaria acuminata</i> Carpentaria Palm	
S	10b-11 No
Slow	35-40↑ 8-10⇒
○○●○	Any
☾☾	Medium
☀	L-N
white/cream, spring through fall flowers; tolerates occasionally wet soil; can cause skin irritation	



<i>Caryota mitis</i> Fishtail Palm	
S	10b-11 No
	15-25↑ 10-15⇒
●●●●	Any
☾	Medium
☀ ☁ ☁	U
multi-stemmed clumps; light green leaflets shaped like fish's tail fin; caution - may be invasive in South Florida	



<i>Ceratozamia hildae</i> Bamboo Cycad	
N C S	8-11 No
Slow	5-7↑ 3-5⇒
○○●○	Any
☾☾	High
☀ ☁ ☁	L-N
sharp thorns, plant away from sidewalks	



<i>Ceratozamia kuesteriana</i>	
N C S	8-11 No
Slow	4-5↑ 3-4⇒
○○●○	Any
☾☾	High
☀ ☁ ☁	L-N
emergent growth on some forms has a reddish color	

Scientific Common
Reg/Native
G, H, S
Soil pH, Txt
Soil Mst, Drgt
Light/Best Salt
Wildlife



<i>Chamaedorea</i> spp. Chamaedorea, Bamboo Palm, Miniature Fishtail Palm
N C S variable No
Fast 1-20↑ 2-8⇔
○○○○○ Any
☾ Medium
☀ ☁ L-N
Wildlife
species needs vary, choose based on conditions; cream, spring through summer flowers; good container plant; potential skin irritant



<i>Chamaerops humilis</i> European Fan Palm
N C S 8-11 No
Slow 5-15↑ 6-15⇔
○○○○○ Any
☾ High
☀ ☁ M
Wildlife
clumping palm; yellow, summer flowers; susceptible to pests; very cold-hardy; petioles with sharp teeth



<i>Dypsis lutescens</i> Yellow Butterfly Palm
S 10a-11 No
15-25↑ 6-10⇔
○○○○○ Any
☾☿ High
☀ ☁☾ M
Wildlife
tolerates occasionally wet soil; high wind resistance; susceptible to pest and K deficiency; caution - may be invasive in South Florida



<i>Coccolthrinax argentata</i> Silver Palm
S 10b-11 Yes
Fast 3-15↑ 6-7⇔
●●●● Any
☾ High
☀ ☁☾ H
Wildlife
distinctive, dark, blue-green, drooping, deeply divided palmate leaves; white, summer flowers; Key Deer food source; high wind resistance

Scientific Common
Reg/Native
G, H, S
Soil pH, Txt
Soil Mst, Drgt
Light/Best Salt
Wildlife



<i>Dioon edule</i> Dioon, Chamal, Mexican Sago
N C S 8-11 No
Slow 1-8↑ 4-6⇔
●●●● Any
☾ High
☀ M
Wildlife
leaflets very sharp; can tolerate adverse conditions for periods; susceptible to pests



<i>Howea forsterana</i> Kentia Palm, Sentry Palm
S 10-11 No
15-25↑ 6-10⇔
○○○○○ S/L
☾ Medium
☀ ☁☾ L-N
Wildlife
white, summer flowers; susceptible to diseases



<i>Licuala grandis</i> Ruffled Fan Palm, Vanuatu Fan Palm, Licuala Palm
S 10b-11 No
Slow 6-12↑ 3-6⇔
○○○○○ S/L
☾ Medium
☀ ☁☾ L-N
Wildlife
white, year-round flowers



<i>Livistona</i> spp. Chinese Fan Palm
C S 9-11 No
20-50↑ 8-15⇔
○○○○○ S/L
☾ High
☀ ☁☾ M
Wildlife
flowers vary; stately palm with single trunk; susceptible to scales; caution - <i>L. chinensis</i> may be invasive in Central and South Florida

Palms & Palm-Like Plants

Scientific Common
Reg/Native
G, H, S
Soil pH, Txt
Soil Mst, Drgt
Light/Best Salt
Wildlife



<i>Nolina recurvata</i> Ponytail Palm
S 10a-11 No
Slow 10-15↑ 12-18⇒
●●●● Any
High
☀ ☁ ☁ M
unique plume of long leaves atop a single trunk with a bulb-like base; susceptible to pests and diseases



<i>Phoenix</i> spp. except <i>Phoenix reclinata</i> Date Palms
N C S 8-11 No
Slow 6-80↑ 6-25⇒
○●●○ S/L
High
☀ ☁ M
yellow, summer flowers; <i>Phoenix canariensis</i> , <i>Phoenix dactylifera</i> and <i>Phoenix roebelinii</i> have high wind resistance; provides food for wildlife



<i>Pseudophoenix sargentii</i> Buccaneer Palm, Sargent's Palm
S 10a-11 Yes
Slow 10-40↑ 10-20⇒
●●●● Any
High
☀ M
yellow, summer flowers; produces grape-sized red fruit; endangered in Florida



<i>Ptychosperma elegans</i> Alexander Palm, Solitary Palm, Solitaire Palm
S 10a-11 No
Slow 15-25↑ 6-10⇒
○●●○ S/L
High
☀ ☁ L-N
white, summer flowers; resistant to lethal yellowing; high wind resistance; caution - may be invasive in South and Central Florida



<i>Ptychosperma macarthurii</i> Macarthur Palm
S 10b-11 No
15-25↑ 6-10⇒
○●●○ S/L
None
☀ ☁ ☁ L-N
noted for multiple, slim, ringed grey trunks; soft green, feathery, flat, broad leaves; branched flower stalks with white, summer flowers; bright red, showy sprays of fruit



<i>Ravenea rivularis</i> Majesty Palm
S 10a-11 No
50-80↑ 10-15⇒
○●●○ C/L
High
☀ ☁ M
feather-leaved with symmetrical, smooth, flared trunk; creamy white, summer flowers



<i>Rhapidophyllum hystrix</i> Needle Palm
N C S 8-11 Yes
Fast 6-8↑ 5-10⇒
○●●○ S/L
Medium
☀ ☁ ☁ L-N
red, summer flowers; yellowish fruit provides food for wildlife



<i>Rhapis excelsa</i> Lady Palm
C S 9-11 No
Slow 7-14↑ 10-15⇒
○●●○ S/L
Medium
☀ ☁ L-N
forms clumps of bamboo-like stalks topped with very dark green fan-shaped leaves; susceptible to pests and disease

Scientific Common
Reg/Native
G, H, S
Soil pH, Txt
Soil Mst, Drgt
Light/Best Salt
Wildlife



<i>Rhaps humilis</i> Slender Lady Palm
C S 9b-11 No
5-7↑ 6-10⇒
○●●○ S/L
☾☾ Medium
☀☁ M
slender stems; drooping leaf segments; forms densely packed clumps; susceptible to pests



<i>Roystonea regia</i> Royal Palm
S 10a-11 Yes
50-80↑ 15-25⇒
●●●○ Any
☾☾ Medium
☀☁ M
tall, smooth, cement gray trunk; beautiful, broad, dense crown of soft, gently drooping, feathery fronds; fragrant, yellow, summer flowers; high wind resistance



<i>Sabal etonia</i> Scrub Palmetto
C S 9-11 Yes
Slow 4-6↑ 4-6⇒
●●●● S/L
☾ High
☀☁ M
small, white, spring through summer flowers; small, black berries in summer through fall provide food for wildlife; long-lived; difficult to transplant



<i>Sabal minor</i> Dwarf Palmetto, Blue-stem Palmetto
N C S 8-10 Yes
Slow 4-9↑ 4-8⇒
●●●● Any
☾☾ High
☀☁☁ M
bluish green, fan shaped leaves; small, white flowers; black berries provides food for wildlife in fall; difficult to transplant; good understory plant; prefers moist soils but tolerates drier conditions after establishment

Scientific Common
Reg/Native
G, H, S
Soil pH, Txt
Soil Mst, Drgt
Light/Best Salt
Wildlife



<i>Sabal palmetto</i> Cabbage Palm, Sabal Palm, Cabbage Palmetto
N C S 8b-11 Yes
Slow 25-60↑ 10-15⇒
●●●● Any
☾☾☾ High
☀☁ H
Florida state tree; white, summer flowers; susceptible to some pests and disease; high wind resistance; older palms transplant easily; provides food and cover for wildlife



<i>Serenoa repens</i> Saw Palmetto
N C S 8-11 Yes
Slow 3-10↑ 4-10⇒
●●●● Any
☾ High
☀☁☁ H
flammable - in wildfire prone areas, plant minimum 30' from buildings; yellow/white, spring flowers; difficult to transplant; grows on first dune; round black fruits provide food for wildlife



<i>Thrinax morrisii</i> Brittle Thatch Palm, Key Thatch Palm
S 10b-11 Yes
Slow 15-20↑ 6-10⇒
●●●● Any
☾☾ High
☀☁ H
green and silver fronds; small, white, summer flowers; tolerates occasionally wet soil; high wind resistance



<i>Thrinax radiata</i> Florida Thatch Palm
S 10b-11 Yes
Slow 15-25↑ 6-10⇒
●●●● S
☾ High
☀☁ H
white; summer flowers; good palm for many landscapes due to small size; high wind resistance

Palms & Palm-Like Plants

Scientific Common
Reg/Native
G, H, S
Soil pH, Txt
Soil Mst, Drgt
Light/Best Salt
Wildlife



<i>Trachycarpus fortunei</i> Windmill Palm	
N C S	8-11 No
10-25↑ 6-10⇒	
●●●●	Any
☾	Medium
☀ ☁	M
	
dense, brown, hair-like fibers that resemble burlap wrapping; 3-foot wide, fan-shaped fronds; inconspicuous, fragrant, summer flowers; good palm for shaded landscapes; tolerates occasional sun; susceptible to pests and disease	





<i>Washingtonia robusta</i> Washington Palm	
N C	9a-11 No
60-90↑ 10-15⇒	
●●●●	Any
☾	High
☀ ☁	M
too tall for most home landscapes; caution – may be invasive in South Florida	



<i>Wodyetia bifurcata</i> Foxtail Palm	
S	10-11 No
Slow	20-30↑ 8-20⇒
○●●○	Any
☾	Medium
☀ ☁	M
pale green, arching fronds with leaflets radiating from leaf stem, giving appearance of bottlebrush or foxtail; white, spring flowers; colorful clusters of red to orange/red fruit	



<i>Zamia floridana</i> Coontie, Florida Arrowroot, Florida Zamia	
N C S	8b-11 Yes
Fast	1-5↑ 3-5⇒
●●●●	Any
☾	High
☀ ☁	H
 	
small palm-like perennial plant; Florida's only native cycad; sole larval food plant for atala hair-streak butterfly; susceptible to pests and cold damage in the 20's	



<i>Zamia furfuracea</i> Cardboard Plant	
C S	9b-11 No
Slow	2-5↑ 5-8⇒
●●●●	Any
☾	High
☀ ☁	H
seeds and caudex poisonous; freezes in central Florida and can come back	

Scientific Common
Reg/Native
G, H, S
Soil pH, Txt
Soil Mst, Drgt
Light/Best Salt
Wildlife

NOTES

A series of 20 horizontal dotted lines for writing notes.

Ferns

Scientific Common
Reg/Native
G, H, S
Soil pH, Txt
Soil Mst, Drgt
Light/Best Salt
Wildlife



<i>Acrostichum danaeifolium</i> Leather Fern	
C S	9-11 Yes
8-10↑ 8-10⇔	
●●●○	Any
☾	Low
☀ ☁ ☂	M
large fern; good for wet sites in shaded landscape; prolonged sunlight, especially in the summer, can burn foliage	



<i>Adiantum capillus-veneris</i> Southern Maidenhair Fern, Venus' Hair Fern	
S	10-11 Yes
Slow	2-3↑ 2-3⇔
●●●○	Any
☾	Low
☀ ☁ ☂	L-N
fine-textured, delicate, fern with light grey-green, soft foliage; tolerates occasionally wet soil	



<i>Blechnum serrulatum</i> Swamp Fern, Toothed Midsorus Fern, Saw Fern	
N C S	8-11 Yes
	1-6↑ 2-6⇔
●●●○	Any
☾	Low
☀ ☁ ☂	L-N
hardy fern; forms underground stems, persisting for many years, and spreads widely (forms dense clumps); grows in full sun if in moist conditions	



<i>Cyrtomium falcatum</i> Holly Fern	
N C S	8b-11 No
	2-3↑ 3-4⇔
○●●○	Any
☾	Medium
☀ ☁ ☂	L-N
evergreen fern; good low-maintenance groundcover; susceptible to pests	

Scientific Common
Reg/Native
G, H, S
Soil pH, Txt
Soil Mst, Drgt
Light/Best Salt
Wildlife



<i>Dicksonia antarctica</i> Tasmanian Tree Fern, Australian Tree Fern	
C S	9-11 No
Slow	20-50↑ 6-20⇔
●●●○	S/L
☾	Low
	☁ L-N
does not tolerate prolonged freezing or direct sun	



<i>Didymochlaena truncatula</i> Mahogany Fern, Tree Maidenhair Fern	
S	10 No
Slow	3-4↑ 4-6⇔
●●●○	Loam
☾	Low
☀ ☁ ☂	U
requires moist soil; do not let dry out between waterings	



<i>Dryopteris</i> spp. Autumn Fern	
N C S	8-11 Var.
Slow	1-4↑ 1-4⇔
●●●○	Any
☾	Medium
☀ ☁ ☂	L-N
dark green fern with delicate appearance; fronds appear reddish when young; choose species based on growing conditions	



<i>Nephrolepis biserrata</i> Giant Sword Fern	
C S	9-11 Yes
	1-4↑ 1-4⇔
○●●○	C/L
☾	Medium
☀ ☁ ☂	L-N
should not be confused with the exotic invasive fern <i>Nephrolepis cordifolia</i> ; may spread beyond small gardens and become difficult to control; looks best in full shade	

Scientific Common
Reg/Native
G, H, S
Soil pH, Txt
Soil Mst, Drgt
Light/Best Salt
Wildlife



<i>Nephrolepis exaltata</i> Sword Fern
C S 9-11 Yes
1-4↑ 1-4⇔
○○○○ C/L
☾ Medium
☀ ☁ L-N
Wildlife

should not be confused with the exotic invasive fern *Nephrolepis cordifolia*; may spread beyond small gardens and become difficult to control; looks best in full shade



<i>Osmunda cinnamomea</i> Cinnamon Fern
N C S 8-10 Yes
Slow 2-5↑ 3-4⇔
●●○○ C/L
☾☾ Low
☀ ☁ L-N
Wildlife

deciduous, shrub-like fern; good plant for detention ponds, swales and canal banks



<i>Osmunda regalis</i> Royal Fern
N C S 8-10 Yes
6-7↑ 6-7⇔
●●○○ Loam
☾☾ Low
☀ ☁ L-N
Wildlife

requires night temperature of 45°F to stay green; susceptible to pests; may be less attractive during winter dormancy

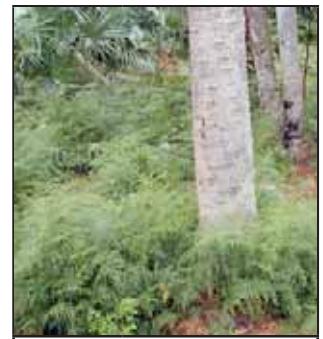

<i>Pteridium aquilinum</i> Bracken Fern
N C S 8-11 Yes
3-6↑ 2-3⇔
●●●○ S/L
☾ Medium
☀ ☁ L-N
Wildlife

fronds triangular in outline

Scientific Common
Reg/Native
G, H, S
Soil pH, Txt
Soil Mst, Drgt
Light/Best Salt
Wildlife



<i>Rumohra adiantiformis</i> Leatherleaf Fern, Seven Weeks Fern
C S 9b-11 No
1-3↑ 4-5⇔
○○○○ Any
☾ Medium
☀ ☁ L-N
Wildlife

evergreen fern with triangular-shaped, dark glossy green leaflets



<i>Sphaeropteris cooperi</i> Australian Tree Fern
S 10b-11 No
Slow 12-18↑ 8-15⇔
○○○○ S/L
☾ Low
☀ ☁ L-N
Wildlife

also known as *Alsophila cooperi*; single-trunked, giant fern



<i>Thelypteris kunthii</i> Southern Shield Fern
N C S 8-11 Yes
Fast 2-3↑ 2-4⇔
○○●● Any
☾☾ Medium
☀ ☁ L-N
Wildlife

robust fern with graceful light green foliage; may spread beyond small gardens and become difficult to control

Perennials

Scientific Common
Reg/Native
G, H, S
Soil pH, Txt
Soil Mst, Drgt
Light/Best Salt
Wildlife



<i>Acalypha reptans</i> Dwarf Chenille Plant
S 10-11 No
Slow to 1↑ varies⇒
●●●○ C/L
☾ Medium
☀ ☁ U
fine-textured, ground-hug-ging; forms a thick canopy of tiny, serrated leaves with bright red flowers



<i>Acrostichum danaeifolium</i> Leather Fern
C S 9-11 Yes
8-10↑ 8-10⇒
●●●○ Any
☾ Low
☀ ☁ ☁ M
large fern; good for wet sites in shaded landscape; prolonged sunlight, especially in the summer, can burn foliage



<i>Adiantum capillus-veneris</i> Southern Maidenhair Fern, Venus' Hair Fern
S 10-11 Yes
Slow 2-3↑ 2-3⇒
○●●○ Any
☾ Low
☁ ☁ L-N
fine-textured, delicate, fern with light grey-green, soft foliage; tolerates occasionally wet soil



<i>Agapanthus africanus</i> Lily of the Nile, African Lily
N C S 8-10 No
Fast 2↑ 2⇒
○●●○ S
☾ Medium
☀ ☁ M
purple/white, summer flowers; deciduous



<i>Agave</i> spp. Century Plant, Agave
N C S 8-11 Var.
Slow 6↑ 4-6⇒
○●●○ S
☾ High
☀ H
dramatic foliage and form; evergreen, silver/gray to blue-green foliage; showy, green-brown fruit; sharp spines; choose species adapted to climate



<i>Aloe</i> spp. Aloe
N C S variable No
varies↑ varies⇒
○●●○ Any
☾ High
☀ ☁ H
species needs vary, choose based on conditions; flowers vary; injured by frost in extreme North Florida; susceptible to caterpillars; size of plant depends on species selection



<i>Alpinia</i> spp. Shell Ginger, Shell Flower
N C S 8-11 No
Fast 6-12↑ 3-5⇒
○●●○ S/C
☾ Low
☀ ☁ M
green and yellow variegated leaves; white, fragrant flowers borne in drooping clusters; will not flower if freezes back

Scientific Common
Reg/Native
G, H, S
Soil pH, Txt
Soil Mst, Drgt
Light/Best Salt
Wildlife

Scientific Common
Reg/Native
G, H, S
Soil pH, Txt
Soil Mst, Drgt
Light/Best Salt
Wildlife



<i>Amorphophallus</i> spp. Voodoo Lily, Snake Lily
N C S 9-11 No
6↑ varies⇒
○○○○ Any
☾ Medium
☀ ☁ L-N
grows very slowly in North Florida; flowers vary, have a foul odor; size of plant depends on species selection



<i>Angelonia angustifolia</i> Angelonia
N C S 9-11 No
Fast 1-3↑ 1-3⇒
○○○○ Any
☾ Medium
☀ U
white and/or blue, summer flowers; can be grown as an annual but survives winters in zones 9 and 10



<i>Asclepias</i> spp. Milkweed, Butterfly Weed
N C S 8-10 Var.
Fast 2-5↑ 1-4⇒
○○○○ Any
☾ Medium
☀ ☁ ☁ L-N
🦋 🐦
species needs vary, choose based on conditions; red/yellow flowers; self-seeds each year; sap may irritate; susceptible to pests and diseases; provides food for butterflies



<i>Asimina</i> spp. Pawpaw
N C S 8-10 Var.
15-20↑ 15-20⇒
○○○○ S
☾ Medium
☀ ☁ ☁ L-N
🦋
deciduous; species needs vary, choose based on conditions; oval, edible fruits with a sweet, rich taste, ripen to a brown/black, wrinkled texture; flowers vary; provides food for zebra swallowtail butterfly

Scientific Common
Reg/Native
G, H, S
Soil pH, Txt
Soil Mst, Drgt
Light/Best Salt
Wildlife



<i>Aspidistra elatior</i> Cast Iron Plant, Barroom Plant
N C S 8b-11 No
Slow 1-3↑ 1-3⇒
○○○○ Any
☾ Medium
☀ ☁ L-N
dark, green foliage with glossy, coarse-texture; brown flowers; tolerates deep shade better than most plants



<i>Begonia</i> <i>Xsemperflorens-cultorum</i> Wax Begonia
N C S 8-11 No
Slow ½-1↑ ½-1⇒
○○○○ Any
☾ Low
☀ ☁ L-N
flowers vary; annual in North and Central regions; susceptible to pests and diseases



<i>Belamcanda chinensis</i> Blackberry Lily
N C S 8-10a No
Fast 1-2↑ 2-4⇒
○○○○ Any
☾ Medium
☀ ☁ M
yellow, spring through fall flowers



<i>Blechnum serrulatum</i> Swamp Fern, Toothed Midsorus Fern, Saw Fern
N C S 8-11 Yes
1-6↑ 2-6⇒
●○○○ Any
☾ Low
☀ ☁ L-N
hardy fern; forms underground stems, persisting for many years, and spreads widely (forms dense clumps); grows in full sun if in moist conditions

Perennials

Scientific Common
Reg/Native
G, H, S
Soil pH, Txt
Soil Mst, Drgt
Light/Best Salt
Wildlife



Bromeliaceae genera
Bromeliads, Airplants

N	C	S	8-11	Var.
Slow	1-2↑	1-2⇔		
○○○○	S			
☾	High			
☀ ☁ ☁	L-N			

flowers, light, region vary; choose species for climate; don't exchange bromeliads from areas with Mexican bromeliad weevil; air circulation prevents scale/mealybugs; cold/ overwatering causes crown rot



Bulbine frutescens
Bulbine

C	S	9-11	No
	1-2↑	1-2⇔	
●●●●	Any		
☾	Medium		
☀ ☁	U		

orange/yellow, spring through summer flowers; clumping; best used as groundcover or container plant



Caladium Xhortulanum
Caladium

N	C	S	8-11	No
Fast	1-2↑	1-2⇔		
○○○○	Any			
☾	Medium			
☀ ☁ ☁	L-N			

good container plant; attractive foliage (red/rose/pink/white/ silver/bronze/ green); leaves die back in the fall; goes dormant; susceptible to pests and diseases



Canna spp.
Canna Lily

N	C	S	8-11	Var.
Fast	2-6↑	1-3⇔		
●●●○	Any			
☾	Medium			
☀ ☁ ☁	L-N			

many cultivars; attractive foliage; summer flowers vary; except *Canna indica*



Catharanthus roseus
Periwinkle, Madagascar Periwinkle, Vinca

C	S	9b-11	No
	1-2↑	1-2⇔	
○○○○	Any		
☾	High		
☀ ☁	M		

white/pink/purple, year-round flowers; watch for micronutrient deficiencies/disease with too much moisture; caution - may be invasive in South Florida



Conradina spp.
False Rosemary, Scrub Mints, Beach Rosemary

N	C	8-9	Yes
Fast	1-3↑	1-3⇔	
○○○○	Any		
☾	High		
☀	H		

blue, year-round flowers; used in beach landscaping



Coreopsis spp.
Tickseed, Coreopsis

N	C	S	8a-10b	Var.
Fast	1-4↑	1-3⇔		
●●○○	Any			
☾	High			
☀ ☁	M			

Florida's state wildflower; orange/yellow, summer flowers; may be annual or short-lived perennial, depending on species



Costus spp.
Spiral Ginger

N	C	S	8-11	No
Fast	6-10↑	4-8⇔		
○○○○	Any			
☾	Low			
☀ ☁ ☁	L-N			

white, fragrant, summer through fall flowers

Scientific Common
Reg/Native
G, H, S
Soil pH, Txt
Soil Mst, Drgt
Light/Best Salt
Wildlife



<i>Crinum</i> spp. Crinum Lily
N C S 8b-11 Var.
Fast 3-6↑ 3-6⇌
●●●○ Any
☾ Medium
☀ ☁ M
many cultivars; fragrant, spidery, year-round flowers vary; poisonous; susceptible to pests and diseases



<i>Crossandra</i> spp. Firecracker Flower
S 10 No
Fast ½-4↑ 1-3⇌
●●●○ S/L
☾☾ Medium
☁ L-N
species needs vary, choose based on conditions; flowers vary; can be used as annual in North and Central region



<i>Cuphea hyssopifolia</i> Mexican Heather, False Heather
N C S 8b-11 No
1-2↑ 2-3⇌
●●●○ Any
☾ High
☀ ☁ M
🦋
purple/white/pink, year-round flowers; susceptible to pests, diseases, and freezes



<i>Curcuma</i> spp. Curcuma, Hidden Lily
N C S 8b-11 No
Fast 1-6↑ 1-4⇌
●●●○ Any
☾☾ Medium
☁ L-N
pink/yellow, spring flowers

Scientific Common
Reg/Native
G, H, S
Soil pH, Txt
Soil Mst, Drgt
Light/Best Salt
Wildlife



<i>Dianella</i> spp. Flax Lily
N C S 8-11 Var.
Fast 1-2↑ 1-2⇌
●●●○ Any
☾ High
☀ ☁ U
blue/yellow flowers; strappy leaves; <i>except Dianella ensifolia</i>



<i>Dicksonia antarctica</i> Tasmanian Tree Fern, Australian Tree Fern
C S 9-11 No
Slow to 50↑ 6-20⇌
●●●○ S/L
☾ Low
☁ L-N
does not tolerate prolonged freezing or direct sun



<i>Didymochlaena truncatula</i> Mahogany Fern, Tree Maidenhair Fern
S 10 No
Slow 3-4↑ 4-6⇌
●●●○ Loam
☾☾ Low
☁ ☁ U
requires moist soil; do not let dry out between waterings



<i>Diets iridoides</i> African Iris, Butterfly Iris
N C S 8b-11 No
Slow 2-6↑ 1-2⇌
●●●○ Any
☾☾☾ Medium
☀ ☁ L-N
also known as <i>Moraea iridoides</i> and <i>Moraea vegeta</i> , previously <i>Diets vegeta</i> ; 1-2" white/yellow/blue, spring through summer flowers

Perennials

Scientific Common
Reg/Native
G, H, S
Soil pH, Txt
Soil Mst, Drgt
Light/Best Salt
Wildlife



<i>Dryopteris</i> spp. Autumn Fern	
N C S	8-11 Var.
Slow	1-4↑ 1-4⇔
●●○○	Any
☾	Medium
☀ ☁	L-N
dark green fern with delicate appearance; fronds appear reddish when young; choose species based on growing conditions	



<i>Dyschoriste oblongifolia</i> Twin Flower, Oblongleaf Snakeherb	
N C S	8-11 Yes
Fast	½-1↑ 1-1½⇔
○○●●	Any
☾	High
☀ ☁	L-N
butterfly	
lavender, year-round flowers; commonly used as groundcover	



<i>Echinacea purpurea</i> Purple Coneflower	
N C S	8-10 Yes
	1-3↑ 2-3⇔
○●●●	C/L
☾	High
☀ ☁	L-N
butterfly, bird	
purple, spring through summer flowers; tolerates occasionally wet soil	

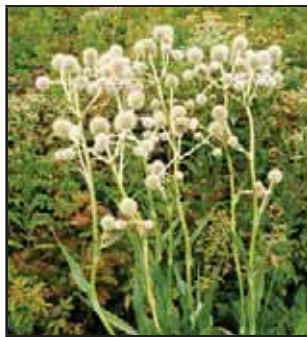

<i>Eryngium yuccifolium</i> Button Rattlesnake Master	
N C S	8-10a Yes
Slow	2-5↑ 2-4⇔
●●●○	Any
☾	
☀	L-N
butterfly	
leaves borne in rosettes; interesting foliage and flowers; great accent plant for a garden	



<i>Euryops</i> spp. Bush Daisy	
N C S	variable No
	3-6↑ 3-6⇔
○○●●	Any
☾	High
☀ ☁	M
species needs vary, choose based on conditions; reseeds readily; resprouts from base in spring; flowers vary	



<i>Evolvulus glomeratus</i> Blue Daze	
C S	9-11 No
	½-1↑ 1-2⇔
○○●●	Any
☾	Medium
☀ ☁	H
creates grey/green carpet-like cover accented with sky blue, spring through summer flowers	



<i>Flaveria linearis</i> Yellowtop	
S	10a-11 Yes
Fast	2-4↑ 2-4⇔
●●●●	Any
☾	High
☀	M
butterfly	
showy clusters of yellow disk shaped, year-round flowers; grows in soils with poor nutrient content; provides food for butterflies	



<i>Gaillardia pulchella</i> Blanket Flower	
N C S	8a-11 Yes
Fast	1-2↑ 2-3⇔
○○●●	S/L
☾	High
☀	M
butterfly	
yellow/orange/red, summer flowers; rounded clumps of soft, hairy, divided leaves	

Scientific Common
Reg/Native
G, H, S
Soil pH, Txt
Soil Mst, Drgt
Light/Best Salt
Wildlife

Scientific Common
Reg/Native
G, H, S
Soil pH, Txt
Soil Mst, Drgt
Light/Best Salt
Wildlife



<i>Gaura lindheimeri</i> White Gaura, Whirling Butterflies, Lindheimer's Beeblossom
N C 8-9 No
Fast 1-3↑ 2-3⇌
○○○○ Any
High
☀ ☁ L-N
🦋
fine-textured, vase-shaped; pink/white, spring through fall flowers on wand-like stalks



<i>Gazania</i> spp. Gazania, Treasure Flower
N C S 8b-11 No
Fast ½-1↑ 1-2⇌
○○○○ Any
High
☀ M
yellow/orange/red, summer flowers; roots may rot from overwatering



<i>Gloriosa</i> spp. Gloriosa Lily
N C S 8-10 No
Fast 2-8↑ 2-8⇌
○○○○ S/C
Medium
☀ ☁ U
crimson/yellow-orange, spring through summer flowers; grows well on trellises



<i>Haemanthus multiflorus</i> Blood Lily
N C S 8-11 No
Slow 1½↑ 1⇌
○○○○ S/L
Medium
☀ ☁ U
also known as <i>Scadoxus</i> <i>multiflorus</i> ; red, summer flowers

Scientific Common
Reg/Native
G, H, S
Soil pH, Txt
Soil Mst, Drgt
Light/Best Salt
Wildlife



<i>Hedychium</i> spp., hybrids and cvs. Butterfly Lily, Butterfly Ginger
N C S 8b-11 No
Fast 4-8↑ 2-4⇌
○○○○ S/L
Low
☀ ☁ ☁ M
🦋
white/yellow/red, spring flowers; thrives in boggy soils



<i>Helianthus angustifolius</i> Swamp Sunflower, Narrowleaf Sunflower
N C S 8b-10 Yes
Fast 2-4↑ 2-4⇌
●●●○ Any
Medium
☀ H
🦋 🐦
perennial, yellow/brown, fall flowers



<i>Helianthus debilis</i> Beach Sunflower
N C S 8b-11 Yes
Fast 1-4↑ 2-4⇌
●●●○ S/L
High
☀ H
🦋 🐦
perennial; yellow/purple, year-round flowers; good groundcover for beaches and dune stabilization; develops fungus if planted in wet areas



<i>Heliconia</i> spp. Heliconia
S 10b-11 No
Fast 2-15↑ 3-6⇌
●●●● Any
None
☀ ☁ L-N
year-round flowers vary

Perennials

Scientific Common
Reg/Native
G, H, S
Soil pH, Txt
Soil Mst, Drgt
Light/Best Salt
Wildlife



<i>Heliotropium angiospermum</i> Scorpion Tail	
N C S	8-11 Yes
1-2↑ 1-2⇒	
●●●●	Any
High	
☀ ☁	L-N
🦋 🐦	
evergreen; white, year-round flowers; seedlings volunteer readily	



<i>Hemerocallis</i> spp. Daylily	
N C S	8-10 No
Fast	1-3↑ 1-2⇒
●●●○	Any
Medium	
☀ ☁	H
🦋 🐦	
many cultivars; summer flowers vary; susceptible to diseases	



<i>Hippeastrum</i> spp. and hybrids Amaryllis	
N C S	8-10 No
1-3↑ 1-3⇒	
○●●○	Any
Medium	
☀ ☁	L-N
large red/white, spring flowers in clusters of two to five; semi-evergreen	



<i>Hymenocallis</i> spp. Spider Lily	
N C S	8-11 Var.
Fast	1-3↑ 3-5⇒
●●●○	Any
High	
☀ ☁	H
region depends on species - choose species adapted to your area; white/yellow, spring through fall flowers	

Scientific Common
Reg/Native
G, H, S
Soil pH, Txt
Soil Mst, Drgt
Light/Best Salt
Wildlife



<i>Impatiens</i> spp. Impatiens	
N C S	8-11 No
½-1↑ 1⇒	
○●●○	Any
High	
☀ ☁	L-N
🦋	
annual with brilliantly marked foliage and ability to tolerate great amounts of sun; flowers vary	



<i>Iris hexagona</i> Louisiana Iris, Blue Flag Iris	
N C S	8-10 No
2-5↑ ½⇒	
●●●○	S/L
Low	
☀ ☁	L-N
purple, spring flowers; flowers best in full sun; good for rain gardens	



<i>Iris virginica</i> Virginia Iris, Blue Flag Iris	
N C S	8b-11 Yes
4-7↑ 1-3⇒	
●●●○	Any
Medium	
☀ ☁	L-N
textured, light-green foliage emerging in dense clumps; lavender, spring flowers; good for rain gardens	



<i>Justicia brandegeana</i> Shrimp Plant	
N C S	8b-11 No
Fast	2-6↑ 2-4⇒
●●●○	Any
Medium	
☀ ☁	L-N
🦋 🐦 🐦	
white, summer flowers; susceptible to pests and freezes	

Scientific Common
Reg/Native
G, H, S
Soil pH, Txt
Soil Mst, Drgt
Light/Best Salt
Wildlife



<i>Justicia carnea</i> Jacobinia, Flamingo Plant
N C S 8b-11 No
Slow 3-6↑ 2-3⇔
●●●○ Any
☾ Low
☀ ☁ L-N
🦋
evergreen; summer through fall flowers vary; susceptible to pests, diseases, and freezes



<i>Justicia spicigera</i> Orange Plum
S 10b-11 No
Fast 5↑ 3-5⇔
●●●● Any
☾ Low
☀ L-N
orange; summer flowers



<i>Kaempferia</i> spp. Peacock Ginger
N C S 8-10 No
Fast 2↑ 1-4⇔
○●●○ C/L
☾☾ Medium
☀ ☁ L-N
intricate foliage patterns in colors of burgundy and bronze; small, four-petaled, violet to purple flowers



<i>Kalanchoe blossfeldiana</i> Kalanchoe, Madagascar Widow's Thrill
S 10-11 No
Slow ½-1↑ ½-1⇔
○●●○ S/L
☾ High
☀ ☀ M
succulent; dark green with scallop edged leaves; pink/red/yellow, winter through spring flowers

Scientific Common
Reg/Native
G, H, S
Soil pH, Txt
Soil Mst, Drgt
Light/Best Salt
Wildlife



<i>Lantana involucrata</i> Wild Sage, Buttonsage
C S 9-11 Yes
Fast 2-5↑ 1-5⇔
●●●○ S/L
☾☾ Medium
☀ H
🦋 🐦
white, year-round flowers



<i>Leonotis leonurus</i> Lion's Ear
C S 9-11 No
Fast 4-5↑ 2-3⇔
○●●○ Any
☾ High
☀ ☁ ☁ H
🦋 🦋
orange/red, summer through winter flowers



<i>Liatris</i> spp. Blazing Star
N C S 8-10b Var.
3↑ ½-1⇔
○●●○ Any
☾☾ Medium
☀ ☀ L-N
🦋
lavender/pink/white, summer through fall flowers

Perennials



Scientific Common			
Reg/Native		8-9 No	
G, H, S		1½↑ 1⇒	
Soil pH, Txt		Any	
Soil Mst, Drgt		Medium	
Light/Best Salt		L-N	
Wildlife			
flower after heavy summer rains; yellow/red/pink, early fall flowers			



Scientific Common			
Reg/Native		9b-11 No	
G, H, S		Fast 7-30↑ 10-15⇒	
Soil pH, Txt		Any	
Soil Mst, Drgt		Low	
Light/Best Salt		L-N	
Wildlife			
edible fruit; showy purple or orange flowers; needs regular watering; susceptible to disease, pests, and frost			



Scientific Common			
Reg/Native		8b-11 No	
G, H, S		2-3↑ 2-3⇒	
Soil pH, Txt		Any	
Soil Mst, Drgt		Low	
Light/Best Salt		L-N	
Wildlife			
clumping herbaceous perennial; white/blue, spring through fall flowers			



Scientific Common			
Reg/Native		8b-11 No	
G, H, S		2-6↑ 2-3⇒	
Soil pH, Txt		S/L	
Soil Mst, Drgt		Medium	
Light/Best Salt		L-N	
Wildlife			
herbaceous perennial; red, fall through winter flowers			



Scientific Common			
Reg/Native		9-11 No	
G, H, S		2-3↑ 2-3⇒	
Soil pH, Txt		Any	
Soil Mst, Drgt		Low	
Light/Best Salt		L-N	
Wildlife			



Scientific Common			
Reg/Native		8-10 Yes	
G, H, S		Slow 2-5↑ 3-4⇒	
Soil pH, Txt		C/L	
Soil Mst, Drgt		Low	
Light/Best Salt		L-N	
Wildlife			
deciduous, shrub-like fern; good plant for retention ponds, swales and canal banks			



Scientific Common			
Reg/Native		8-10 Yes	
G, H, S		6-7↑ 6-7⇒	
Soil pH, Txt		Loam	
Soil Mst, Drgt		Low	
Light/Best Salt		L-N	
Wildlife			
requires night temperature of 45°F to stay green; susceptible to pests; may be less attractive during winter dormancy			



Scientific Common			
Reg/Native		9b-11 No	
G, H, S		2-3↑ 2-3⇒	
Soil pH, Txt		Any	
Soil Mst, Drgt		Low	
Light/Best Salt		L-N	
Wildlife			
yellow, spring through fall flowers			

Scientific Common
Reg/Native
G, H, S
Soil pH, Txt
Soil Mst, Drgt
Light/Best Salt
Wildlife



<i>Pentas lanceolata</i> Pentas, Starflower
N C S 8b-11 No
Fast 2-4↑ 2-3⇌
○○●○○ Any
☾ Medium
☀ ☁ M
🦋 🦅
many cultivars; red/pink/white/lilac, summer flowers; susceptible to freeze damage



<i>Philodendron</i> spp. and cvs. Philodendron
C S 8b-11 No
Fast 1-12↑ 2-15⇌
○○●○○ Any
☾☾☾ Medium
☀ ☁ ☁ L-N
select species based on site conditions; check with your local Extension office before final species selection; except <i>Monstera deliciosa</i>



<i>Phlox divaricata</i> Blue Phlox
N C S 8-11 No
Fast 1-3↑ 1-3⇌
●●●○○ Any
☾ Medium
☀ ☁ L-N
purple, summer flowers



<i>Plectranthus</i> spp. Plectranthus
N C S 8-11 No
Fast 1-5↑ 1-4⇌
○○●○○ S/L
☾☾ Medium
☀ ☁ L-N
flowers vary; 'Mona Lavender' was ENGLA Plant of the Year in 2004

Scientific Common
Reg/Native
G, H, S
Soil pH, Txt
Soil Mst, Drgt
Light/Best Salt
Wildlife



<i>Plumbago auriculata</i> cvs. Plumbago
C S 9-11 No
Fast 6-10↑ 8-10⇌
●●●○○ Any
☾ Medium
☀ L-N
🦋
blue/white, year-round flowers; susceptible to pests and freezes



<i>Pteridium aquilinum</i> Bracken Fern
N C S 8-11 Yes
3-6↑ 2-3⇌
●●●○○ S/L
☾ Medium
☀ ☁ L-N
fronds triangular in outline



<i>Rudbeckia fulgida</i> Rudbeckia
N C 8-9 Yes
Fast 3↑ 3⇌
○○●○○ S/L
☾ Low
☀ ☁ L-N
🦋 🦅
showy, daisy-like flower; produces masses of golden color all summer



<i>Rudbeckia hirta</i> Black-Eyed Susan
N C 8-9 Yes
2-3↑ 1-2⇌
○○●○○ Any
☾ Medium
☀ ☁ L-N
🦋 🦅
large, yellow-orange to red-dish-orange, summer flowers; does not tolerate prolonged, wet weather

Perennials

Scientific Common
Reg/Native
G, H, S
Soil pH, Txt
Soil Mst, Drgt
Light/Best Salt
Wildlife



<i>Salvia</i> spp. Salvia, Sage
N C S 8a-11 Var.
Fast 1-8↑ 1-10⇒
○○○○○ S
☹️ Medium
☀️ L-N
🦋 🐦
flowers vary



<i>Sisyrinchium angustifolium</i> Blue-eyed Grass
N C S 8-11 Yes
Fast ½-1½↑ ½-1½⇒
●●●○○ Any
☹️ Medium
☀️ ☁️ L-N
blue, spring flowers



<i>Solenostemon scutellarioides</i> Coleus
N C S 8-11 No
Fast 1-3↑ 1-3⇒
○○○○○ Any
☹️ Low
☀️ ☁️ L-N
purple, summer flowers; many cultivars; 'Hurricane Louise' was FNGLA Plant of the Year in 2005; susceptible to pests and diseases



<i>Solidago</i> spp. Goldenrod
N C S 8-10 Var.
2-6↑ ½-2⇒
●●●○○ S
☹️☹️☹️ High
☀️ ☁️ H
🦋 🐦
yellow, summer through fall flowers; some species form large colonies; <i>Solidago odora</i> is the Florida native



<i>Sphaeropteris cooperi</i> Australian Tree Fern
S 10b-11 No
Slow 12-18↑ 8-15⇒
○○○○○ S/L
☹️ Low
☁️ ☁️ L-N
also known as <i>Alsophila cooperi</i> ; single-trunked, giant fern



<i>Sprekelia formosissima</i> Aztec Lily, Jacobean Lily, St. James Lily
N C S 8-10b No
Fast 1-2↑ 1-2⇒
○○○○○ S/L
☹️ Low
☀️ ☁️ M
red, spring through summer flowers



<i>Stachytarpheta</i> spp. Porterweed
N C S 8-11 Var.
Fast 2-8↑ 3-4⇒
○○○○○ Any
☹️☹️ Medium
☀️ ☁️ M
🦋
flowers vary



<i>Stokesia laevis</i> Stokes' Aster
N C 8-9 Yes
Fast 1-2↑ 1-2⇒
●●○○○ S/L
☹️ High
☀️ L-N
🦋
blue/white, summer flowers; many cultivars

Scientific Common
Reg/Native
G, H, S
Soil pH, Txt
Soil Mst, Drgt
Light/Best Salt
Wildlife

Scientific Common
Reg/Native
G, H, S
Soil pH, Txt
Soil Mst, Drgt
Light/Best Salt
Wildlife



<i>Strobilanthes dyerianus</i> Persian Shield	
C S	9-11 No
3-4↑ 2-3⇒	
●●●●	
None	
☀ ☁	M
good, showy foliage plant with metallic purple leaves	



<i>Tulbaghia violacea</i> Society Garlic	
N C S	8a-11 No
1-2↑ 1-2⇒	
○●●○	S/L
High	
☀ ☁	L-N
lavender, spring through fall flowers; plant has strong garlic scent	



<i>Zephyranthes</i> spp. Rain Lily, Zephyr Lily	
N C S	8-11 Var.
Fast	½-1↑ ½-1⇒
●●●○	Any
Medium	
☀ ☁	M
white/yellow/pink/red, spring through fall flowers; susceptible to pests	



<i>Zingiber zerumbet</i> Pine Cone Ginger	
N C S	8-11 No
4-7↑ 4-6⇒	
●●●○	Any
Medium	
☀ ☁	M
red, fragrant, fall flowers; tolerates occasionally wet soil	

Annuals



<i>Ageratum</i> spp. Ageratum	
N C S	8-11 No
Fast	1-2↑ 1-2⇌
○●●○	Any
Low	Low
	L-N
many cultivars; purple/white, year-round flowers	



<i>Amaranthus</i> spp. Amaranth	
N C S	8-11 Var.
Fast	1-2↑ 1-2⇌
○●●○	Any
Low	Medium
	M
many cultivars; attractive foliage; inconspicuous flowers	



<i>Angelonia angustifolia</i> Angelonia	
N C S	9-11 No
Fast	1-3↑ 1-3⇌
○●●○	Any
Low	Medium
	U
white and/or blue, summer flowers	



<i>Begonia X semperflorens-cultorum</i> Wax Begonia	
N C S	8-11 No
Slow	1/2-1↑ 1/2-1⇌
○●●○	Any
Low	Low
	L-N
flowers vary; annual in North and Central regions; susceptible to pests and diseases	



<i>Caladium Xhortulanum</i> Caladium	
N C S	8-11 No
Fast	1-2↑ 1-2⇌
○●●○	Any
Low	Medium
	L-N
good container plant; attractive foliage (red/rose/pink/white/ silver/bronze/ green); leaves die back in the fall; goes dormant; susceptible to pests and diseases	



<i>Calendula</i> spp. Pot Marigold	
N C S	8-11 No
Fast	1-1½↑ 1-1½⇌
○●●○	Any
Low	Low
	M
yellow/orange, winter through spring flowers	



<i>Catharanthus roseus</i> Periwinkle, Madagascar Periwinkle, Vinca	
C S	9b-11 No
	1-2↑ 1-2⇌
○●●○	Any
High	High
	M
white/pink/purple, year-round flowers; susceptible to micro-nutrient deficiencies/ disease with too much moisture; caution - may be invasive in South Florida	



<i>Celosia</i> spp. Celosia	
N C S	8-11 No
Fast	1/2-2↑ 1/2-1⇌
○●●○	Any
Low	Low
	L-N
many cultivars; summer flowers vary	

Scientific Common
Reg/Native
G, H, S
Soil pH, Txt
Soil Mst, Drgt
Light/Best Salt
Wildlife

Scientific Common
Reg/Native
G, H, S
Soil pH, Txt
Soil Mst, Drgt
Light/Best Salt
Wildlife

Scientific Common
Reg/Native
G, H, S
Soil pH, Txt
Soil Mst, Drgt
Light/Best Salt
Wildlife



<i>Coreopsis</i> spp. Tickseed, Coreopsis
N C S 8a-10b Var.
Fast 1-4↑ 1-3⇔
●●●○ Any
☾ High
☀ ☁ M
🦋 🐦
Florida's state wildflower; or-ange/yellow, summer flowers; may be annual or short-lived perennial, depending on species



<i>Gazania</i> spp. Gazania, Treasure Flower
N C S 8b-11 No
½-1↑ 1-2⇔
○●●○ Any
☾ High
☀ M
yellow/orange/red, summer flowers; roots may rot from overwatering



<i>Impatiens</i> spp. Impatiens
N C S 8-11 No
½-1↑ 1⇔
○●●○ Any
☾ None
☀ ☁ L-N
🦋
annual with brilliantly marked foliage and ability to tolerate great amounts of sun; flowers vary



<i>Justicia brandegeana</i> Shrimp Plant
N C S 8b-11 No
Fast 2-6↑ 2-4⇔
●●●○ Any
☾ Medium
☀ ☁ L-N
🦋 🐦 🐦
white, summer flowers; susceptible to pests and freezes

Scientific Common
Reg/Native
G, H, S
Soil pH, Txt
Soil Mst, Drgt
Light/Best Salt
Wildlife



<i>Justicia carnea</i> Jacobinia, Flamingo Plant
N C S 8b-11 No
Slow 3-6↑ 2-3⇔
●●●○ Any
☾ Low
☀ ☁ L-N
🐦
evergreen; summer through fall flowers vary; susceptible to pests, diseases, and freezes



<i>Justicia spicigera</i> Orange Plum
S 10b-11 No
Fast 5↑ 3-5⇔
●●●● Any
☾ Low
☀ L-N
orange; summer flowers



<i>Lobularia maritima</i> Sweet Alyssum
N C S 8-11 No
½-1↑ ½-1⇔
●●●○ Any
☾ Medium
☀ ☁ L-N
purple/white/pink, winter flowers; tolerates light frost



<i>Monarda punctata</i> Spotted Horsemint, Dotted Horsemint, Spotted Beebalm
N C 8b-9 Yes
Fast 1-3↑ 2-4⇔
○●●○ Any
☾ Medium
☀ ☁ H
🦋 🐦
pink, summer through fall flowers

Annuals

Scientific Common
Reg/Native
G, H, S
Soil pH, Txt
Soil Mst, Drgt
Light/Best Salt
Wildlife



<i>Pachystachys lutea</i> Golden Shrimp Plant	
C S	9b-11 No
2-3↑ 2-3⇒	
○○○○	Any
Low	
☀ ☁	L-N
butterfly bird	
yellow, spring through fall flowers	



<i>Pentas lanceolata</i> Pentas, Starflower	
N C S	8b-11 No
Fast 2-4↑ 2-3⇒	
○○○○	Any
Medium	
☀ ☁	M
butterfly bird	
many cultivars; red/pink/white/lilac, summer flowers; susceptible to freeze damage	



<i>Petunia X hybrida</i> Petunia	
N C S	8-11 No
Fast ½-1½↑ 1⇒	
○○○○	Any
Low	
☀ ☁	M
butterfly bird	
many flower colors, in fall through spring; can be grown as perennial in South Florida; susceptible to pests and diseases	



<i>Rudbeckia fulgida</i> Rudbeckia	
N C	8-9 Yes
Fast 3↑ 3⇒	
○○○○	S/L
Low	
☀ ☁	L-N
butterfly bird	
showy, daisy-like flower; produces masses of golden color all summer	



<i>Rudbeckia hirta</i> Black-Eyed Susan	
N C	8-9 Yes
2-3↑ 1-2⇒	
○○○○	Any
Medium	
☀ ☁	L-N
butterfly bird	
large, yellow-orange to red-dish-orange, summer flowers; does not tolerate prolonged, wet weather	



<i>Solenostemon scutellarioides</i> Coleus	
N C S	8-11 No
Fast 1-3↑ 1-3⇒	
○○○○	Any
Low	
☀ ☁	L-N
butterfly bird	
purple, summer flowers; many cultivars; 'Hurricane Louise' was FNGLA Plant of the Year in 2005; susceptible to pests and diseases	



<i>Tagetes</i> spp. Marigold	
N C S	8-11 No
Fast 1-3↑ 1⇒	
○○○○	S/L
Medium	
☀ ☁	L-N
butterfly	
flowers vary	



<i>Tithonia rotundiflora</i> Mexican Sunflower	
N C S	8-10 No
Fast 5-6↑ 3-4⇒	
○○○○	Any
High	
☀ ☁	U
butterfly	
red/orange, summer flowers	

Scientific Common
Reg/Native
G, H, S
Soil pH, Txt
Soil Mst, Drgt
Light/Best Salt
Wildlife



<i>Torenia fournieri</i> Wishbone Flower				
N	C	S	8-11	No
		½-1½↑ 1-1½↔		
○○○○		S/L		
☾☾		Low		
☀ ☁ ☁		L-N		
🐦				
lavender/pink/blue/white, spring through fall flowers; susceptible to pests				



<i>Viola</i> spp. Violet, Johnny-jump-up				
N	C		8-9	Var.
Fast		½-1↑ ½-1↔		
○○○○		S/L		
☾☾		Low		
☀ ☁		L-N		
🐦				
cold hardy annual				



<i>Viola X wittrockiana</i> Pansy				
N	C	S	8-11	No
Slow		½-1↑ ½-1↔		
○○○○		Any		
☾		Low		
☀ ☁		L-N		
🐦				
many cultivars; year-round flowers vary; needs regular watering in warm weather				



<i>Zinnia</i> hybrids Zinnia				
N	C	S	8-11	No
Fast		½-3↑ 1↔		
○○○○		Any		
☾		High		
☀		L-N		
🦋 🐦 🐦				
many varieties with wide range of flower colors and sizes, year-round flowering; susceptible to pests and diseases				

Legend for Turfgrass
 MOWING HT: Mowing turf below the recommended height can stress the grass and subject it to invasion by weeds.
 LEAF: Fine, Medium, Coarse, Fine-Medium, Coarse-Medium (Relative measure of leaf blade width. Texture is merely a visual preference.)
 MAINT. LEVEL: Low, Medium, High, Medium-High (Amount of fertilization, irrigation, and mowing required.)
 SOIL pH: Any, Acid (Ideal soil pH and texture for healthy turf.)
 DROUGHT TOLERANCE: Low, Medium, High (Measure of how

well the turf will survive extended dry periods without irrigation or rainfall after it has been properly established.)
 SALT: Low, Medium, High, None (Ability to thrive when subjected to salt stress from irrigation water, saltwater intrusion, or salt spray from the ocean.)
 SHADE: Low, Medium, High (Ability to thrive when exposed to shade.)
 ESTABLISHMENT METHODS: Sod, Sprigs, Plugs, Seed (A quality lawn can be established by any method listed if the site is properly prepared and maintained.)



<i>Cynodon dactylon</i> Bermudagrass			
1-2 in.	F-M	M-H	
Any	Medium	M	L
Sod, sprigs, plugs, some seed			
adapted to entire state; medium wear tolerance; low nematode tolerance			



<i>Eremochloa ophiuroides</i> Centipedegrass			
1.5-2 in.	M	Low	
Acid	Medium	L	M
Sod, sprigs, plugs, seed			
adapted to North Florida and the Panhandle; low wear tolerance; low nematode tolerance			



<i>Paspalum notatum</i> Bahia grass			
3-4 in.	C-M	Low	
Acid	High	N	L
Sod, seed			
adapted to entire state; low wear tolerance; high nematode tolerance			



<i>Stenotaphrum secundatum</i> St. Augustinegrass 'Semi-dwarf cvs.'			
2-2.5 in.	C-M	Medium	
Any	Low	M	V
Sod, sprigs, plugs			
adapted to entire state; low wear tolerance; medium nematode tolerance; shade tolerance varies depending on cultivar selection			



<i>Stenotaphrum secundatum</i> St. Augustinegrass 'Standard height cvs.'			
3.5-4 in.	C-M	Medium	
Any	Low	M	V
Sod, sprigs, plugs			
adapted to entire state; low wear tolerance; medium nematode tolerance; shade tolerance varies depending on cultivar selection			



<i>Zoysia japonica</i> Zoysiagrass			
2-2.5 in.	F-M	High	
Any	Medium	M	V
Sod, sprigs, plugs			
adapted to entire state; medium wear tolerance; low nematode tolerance; shade tolerance varies depending on cultivar selection			

Scientific Common
Mw Ht/Leaf/Mnt Lv
Soil pH/Drgt/Sit/Sh
Estab. Methods

Index

A

African Iris Dietes iridoides Perennial	99	Aloe Aloe spp. Perennial Small Shrub	96 74	American Planetree Platanus occidentalis Large Tree	45	Australian Tree Fern Dicksonia antarctica Fern Perennial	95 99
African Lily Agapanthus africanus Perennial	96	Amaranth Amaranthus spp. Annual	108	American Wisteria Wisteria frutescens Vine	80	Sphaeropteris cooperi Fern Perennial	94 106
Agave Agave spp. Large Shrub Perennial	60 96	Amaryllis Hippeastrum spp. Perennial	102	Angelonia Angelonia angustifolia Annual Perennial	108 97	Autumn Fern Dryopteris spp. Fern Groundcover Perennial	95 82 100
Ageratum Ageratum spp. Annual	108	American Elm Ulmus americana Large Tree	47	Angel's Trumpet Brugmansia Xcandida Large Shrub	62	Avocado Persea americana Large Tree	44
Airplants Bromeliaceae genera Perennial	98	American Holly Ilex opaca Medium Tree	50	Arizona Cypress Cupressus arizonica var. arizonica Medium Tree	49	Awabuki Viburnum Viburnum odoratissimum Small Tree Viburnum odoratissimum var. awabuki Large Shrub	59 73
Alexander Palm Ptychosperma elegans Palm or Palm-Like	90	American Hophornbeam Ostrya virginiana Medium Tree	50	Asiatic Jasmine Trachelospermum asiaticum Groundcover	85	Azalea Rhododendron cvs. Large Shrub	71
		American Hornbeam Carpinus caroliniana Medium Tree Ostrya virginiana Medium Tree	48 50				

B

Bahama Lysiloma Lysiloma latisiliquum Large Tree	44	Barometer Bush Leucophyllum frutescens Small Shrub	75	Bird of Paradise Strelitzia reginae Small Shrub	76	Blanket Flower Gaillardia pulchella Perennial	100
Bahiagrass Paspalum notatum Turfgrass	112	Barroom Plant Aspidistra elatior Groundcover Perennial	82 97	Bismarck Palm Bismarckia nobilis Palm or Palm-Like	88	Blazing Star Liatris spp. Perennial	103
Bald Cypress Taxodium spp. Large Tree	47	Bay Cedar Suriana maritima Large Shrub	72	Blackberry Lily Belamcanda chinensis Perennial	97	Blood Lily Haemanthus multiflorus Perennial	101
Bamboo Bambusa spp. Large Shrub	61	Bay Oak Persea borbonia Medium Tree	50	Black-Eyed Susan Rudbeckia hirta Annual Perennial	110 105	Blue Daze Evolvulus glomeratus Groundcover Perennial	83 100
Bamboo Cycad Ceratozamia hildae Palm or Palm-Like	88	Beach Rosemary Conradina spp. Perennial	98	Black-Eyed Susan Vine Thunbergia alata Vine	80	Blue-eyed Grass Sisyrinchium angustifolium Perennial	106
Bamboo Palm Chamaedorea spp. Palm or Palm-Like	89	Beach Sunflower Helianthus debilis Perennial	101	Black Gum Nyssa sylvatica Large Tree	44	Blue Flag Iris Iris hexagona Perennial Iris virginica Perennial	102 102
Banana Musa spp. Large Shrub Perennial Small Tree	69 104 57	Beautyberry Callicarpa americana Large Shrub	62	Black Ironwood Krugiodendron ferreum Small Tree	56	Blue Phlox Phlox divaricata Perennial	105
Banana Shrub Magnolia figo Small Tree	57	Bermudagrass Cynodon dactylon Turfgrass	112	Black Mangrove Avicennia germinans Medium Tree	48	Bluestem Grass Andropogon spp. Grass	86
		Bigleaf Hydrangea Hydrangea macrophylla Large Shrub	66	Black Olive Bucida buceras Large Tree	42		

Blue-stem Palmetto		Perennial	105	Bulbine		Butterfly Iris	
Sabal minor				Bulbine frutescens		Diets iridoides	
Large Shrub	71	Brazilian Grape		Perennial	98	Perennial	99
Palm or Palm-Like	91	Myrciaria cauliflora					
		Small Tree	57	Bur Oak		Butterfly Lily	
Bluff Oak				Quercus macrocarpa		Hedychium spp.	
Quercus austrina		Brazilian Grape Tree		Large Tree	46	Perennial	101
Large Tree	46	Myrciaria cauliflora					
		Small Tree	57	Bush Clock Vine		Butterfly Weed	
Bottlebrush				Thunbergia erecta		Asclepias spp.	
Callistemon spp.		Bridal Wreath		Large Shrub	72	Perennial	97
Large Shrub	62	Spiraea spp.					
Small Tree	53	Small Shrub	76	Bush Daisy		Buttonbush	
				Euryops spp.		Cephalanthus occidentalis	
Bougainvillea		Brittle Thatch Palm		Perennial	100	Large Shrub	63
Bougainvillea cvs.		Thrinax morrisii		Gamolepis spp.		Small Tree	53
Vine	78	Palm or Palm-Like	91	Small Shrub	74		
						Button Rattlesnake Master	
Bower Vine		Bromeliads		Butterfly Bush		Eryngium yuccifolium	
Pandorea jasminoides		Bromeliaceae genera		Buddleja lindleyana		Perennial	100
Vine	80	Perennial	98	Large Shrub	62		
				Senna bicapsularis		Buttonsage	
Boxthorn		Buccaneer Palm		Large Shrub	71	Lantana involucrata	
Severinia buxifolia		Pseudophoenix sargentii				Perennial	103
Large Shrub	71	Palm or Palm-Like	90	Butterfly Ginger			
				Hedychium spp.		Buttonwood	
Bracken Fern		Buckthorn		Perennial	101	Conocarpus erectus	
Pteridium aquilinum		Sideroxylon spp.				Large Shrub	64
Fern	95	Small Tree	59			Large Tree	42

C

Cabbage Palm		Carolina Allspice		Cedar Elm		Cherokee Bean	
Sabal palmetto		Calycanthus floridus		Ulmus crassifolia		Erythrina herbacea	
Palm or Palm-Like	91	Large Shrub	62	Large Tree	47	Large Shrub	65
Cabbage Palmetto		Carolina Ash		Celosia		Chickasaw Plum	
Sabal palmetto		Fraxinus caroliniana		Celosia spp.		Prunus angustifolia	
Palm or Palm-Like	91	Large Tree	43	Annual	108	Small Tree	58
Caladium		Carolina Buckthorn		Centipedegrass		Chinese Elm	
Caladium Xhortulanum		Rhamnus caroliniana		Eremochloa ophiuroides		Ulmus parvifolia and cvs.	
Annual	108	Large Shrub	70	Turfgrass	112	Large Tree	47
Perennial	98						
		Carolina Coralbead		Century plant		Chinese Fan Palm	
Camellia		Cocculus laurifolius		Agave spp.		Livistona spp.	
Camellia japonica		Large Shrub	64	Large Shrub	60	Palm or Palm-Like	89
Large Shrub	63						
Small Tree	53	Carolina Jessamine		Century Plant		Chinese Fringe Bush	
		Gelsemium sempervirens		Agave spp.		Loropetalum chinense and cvs.	
Candlestick Plant		Vine	78	Perennial	96	Large Shrub	68
Senna alata							
Large Shrub	71	Carolina Silverbell		Chalcas		Chinese Fringetree	
		Halesia carolina		Murraya paniculata		Chionanthus retusus	
Canna Lily		Large Tree	43	Large Shrub	89	Small Tree	54
Canna spp.							
Perennial	98	Carpentaria Palm		Chamaedorea		Chinese Holly	
		Carpentaria acuminata		Chamaedorea spp.		Ilex cornuta and cvs.	
Cape Jasmine		Medium Tree	48	Palm or Palm-Like	89	Large Shrub	67
Gardenia jasminoides		Palm or Palm-Like	88			Small Tree	56
Large Shrub	66			Chamal			
		Cast Iron Plant		Dioon edule		Chinese Juniper	
Capeweed		Aspidistra elatior		Palm or Palm-Like	89	Juniperus chinensis and cvs.	
Phyla nodiflora		Groundcover	82			Large Shrub	68
Groundcover	84	Perennial	97	Chaste Tree			
				Vitex agnus-castus		Chinese Mahonia	
Cardboard Plant		Cat's Whiskers		Large Shrub	73	Mahonia fortunei	
Zamia furfuracea		Orthosiphon aristatus				Small Shrub	75
Groundcover	85	Perennial	104	Chenille Plant			
Palm or Palm-Like	92			Acalypha hispida			
				Small Shrub	74		

Chinkapin Oak Quercus muehlenbergii Large Tree	46	Cocculus Cocculus laurifolius Large Shrub	64	Coral Honeysuckle Lonicera sempervirens Vine	79	Creeping Juniper Juniperus horizontalis and cvs. Groundcover	84
Christmas Berry Lycium carolinianum Small Shrub	75	Cocoplum Chrysobalanus icaco Large Shrub	53	Coral Plant Russelia equisetiformis Small Shrub	76	Creeping Phlox Phlox subulata Groundcover	84
Christmas Senna Senna bicapsularis Large Shrub	71	Coleus Solenostemon scuttellarioides Annual Perennial	110 106	Cordgrass Spartina spp. Grass	87	Creeping Yew Cephalotaxus harringtonia Groundcover	82
Cinnamon Bark Canella winterana Small Tree	53	Common Witchhazel Hamamelis virginiana Large Shrub	66	Coreopsis Coreopsis spp. Annual Perennial	109 98	Crinum Lily Crinum spp. Perennial	99
Cinnamon Fern Osmunda cinnamomea Fern Perennial	95 104	Confederate Jasmine Trachelospermum jasminoides Groundcover Vine	85 80	Cow Itch Vine Decumaria barbara Vine	78	Cross Vine Bignonia capreolata Vine	78
Cleyera Temstroemia gymnanthera Large Shrub	72	Coontie Zamia floridana Groundcover Palm or Palm-Like	85 92	Crabwood Gymnanthes lucida Large Tree	43	Croton Codiaeum variegatum Large Shrub	64
Climbing Aster Aster carolinianus Vine	78	Copper Leaf Acalypha wilkesiana Large Shrub	60	Crape Jasmine Tabernaemontana divaricata Large Shrub	72	Curcuma Curcuma spp. Perennial	99
Climbing Hydrangea Decumaria barbara Vine	78	Coral Bean Erythrina herbacea Large Shrub	65	Crapemyrtle Lagerstroemia indica Medium Tree	50		

D

Dahoon Holly Ilex cassine and cvs. Medium Tree	50	Devilwood Osmanthus americanus Large Shrub Small Tree	69 57	Dwarf Chenille Plant Acalypha reptans Perennial	96	Dwarf Sugar Palm Arenga engleri Palm or Palm-Like Small Tree	88 52
Date Palms Phoenix spp. Palm or Palm-Like	90	Dioon Dioon edule Palm or Palm-Like	89	Dwarf Lilyturf Ophiopogon japonicus and cvs. Groundcover	84		
Daylily Hemerocallis spp. Perennial	102	Doghobble Agarista populifolia Large Shrub	60	Dwarf Liriodie Ophiopogon japonicus and cvs. Groundcover	84		
Desert Cassia Senna polyphylla Large Shrub Small Tree	71 58	Dotted Horsemint Monarda punctata Annual	109	Dwarf Palmetto Sabal minor Large Shrub Palm or Palm-Like	71 91		
Devil's Walkingstick Aralia spinosa Large Shrub Small Tree	61 52	Downy Jasmine Jasminum multiflorum Large Shrub Vine	67 79	Dwarf Pitch Apple Clusia rosea Large Shrub	64		
		Dutchman's Pipe Aristolochia spp. Vine	78	Dwarf Schefflera Heptapleurum arboricola Large Shrub	66		

E

Eastern Redbud Cercis canadensis Medium Tree	48	Elliott's Lovegrass Eragrostis elliottii Grass	86	Eulalia Grass Miscanthus sinensis Grass	86	Evergreen Wisteria Millettia reticulata Vine	79
Eastern Sweetshrub Calycanthus floridus Large Shrub	62	English Dogwood Philadelphus inodorus Large Shrub	70	European Fan Palm Chamaerops humilis Palm or Palm-Like Small Tree	89 54		
East Palatka Holly Ilex Xattenuata and cvs. Medium Tree	49						

F

Fakahatchee Grass Tripsacum dactyloides and cvs. Grass	87	Firecracker Plant Russelia equisetiformis Small Shrub	76	Florida Arrowroot Zamia floridana Groundcover Palm or Palm-Like	85 92	Floss-silk Tree Chorisia speciosa Large Tree	42
False Heather Cuphea hyssopifolia Perennial	99	Firecracker Plant Russelia sarmentosa Small Shrub	76	Florida Buckeye Aesculus pavia Small Tree	52	Flowering Dogwood Cornus florida Small Tree	54
False Rosemary Conradina spp. Perennial	98	Firespike Odontonema strictum Perennial	104	Florida Flame Azalea Rhododendron austrinum Large Shrub	71	Formosa Palm Arenga engleri Palm or Palm-Like Small Tree	88 52
Feijoa Acca sellowiana Large Shrub	60	Firethorn Pyracantha coccinea Small Shrub	75	Florida Gama Grass Tripsacum floridana Grass	87	Fortune's Mahonia Mahonia fortunei Small Shrub	75
Fetterbush Agarista populifolia Large Shrub	60	Fish Poison Tree Piscidia piscipula Large Tree	45	Florida Keys Blackbead Pithecellobium keyense Large Shrub	69	Foxtail Palm Wodyetia bifurcata Palm or Palm-Like	92
Fetterbush Lyonia lucida Small Shrub	75	Fishtail Palm Caryota mitis Palm or Palm-Like	88	Florida Maple Acer barbatum Large Tree	42	Fragrant Olive Osmanthus fragrans Large Shrub	69
Fiddlewood Citharexylum spinosum Large Shrub Small Tree	64 54	Flamingo Plant Justicia carnea Annual Perennial	109 103	Florida Privet Forestiera segregata Large Shrub Small Tree	65 55	Frangipani Plumeria rubra Small Tree	58
Firebush Hamelia patens Large Shrub	66	Flatwoods Plum Prunus umbellata Small Tree	58	Florida Thatch Palm Thrinax radiata Palm or Palm-Like	91	French Hydrangea Hydrangea macrophylla Large Shrub	66
Firecracker Flower Crossandra spp. Perennial	99	Flax Lily Dianella spp. Perennial	99	Florida Zamia Zamia floridana Groundcover Palm or Palm-Like	85 92	Fringetree Chionanthus virginicus Small Tree	54

G

Gallberry Ilex glabra Small Tree	56	Gazania Gazania spp. Annual Perennial	109 101	Giant Bird of Paradise Strelitzia nicolai Large Shrub	72	Gloriosa Lily Gloriosa spp. Perennial	101
Gamma Grass Tripsacum dactyloides and cvs. Grass	87	Geiger Tree Cordia sebestena Medium Tree	49	Giant Sword Fern Nephrolepis biserrata Fern Groundcover	94 84	Glossy Abelia Abelia Xgrandiflora Large Shrub	60
Gardenia Gardenia jasminoides Large Shrub	66					Golden creeper Ernodea littoralis Groundcover	83

Golden Dewdrop Duranta erecta Large Shrub	65
Goldenrod Solidago spp. Perennial	106
Golden Shower Cassia fistula Medium Tree	48

Golden Shrimp Plant Pachystachys lutea Annual Perennial	110 104
Golden Trumpet Tree Tabebuia chryso-tricha Medium Tree	51

Green Ash Fraxinus pennsylvanica Large Tree	43
Gregorywood Bucida buceras Large Tree	42

Groundsel Bush Baccharis halimifolia Large Shrub Small Tree	61 52
Gumbo Limbo Bursera simaruba Medium Tree	48

H

Harrington Plum Yew Cephalotaxus harringtonia Large Shrub Small Tree	63 53
Hawthorn Crataegus spp. Large Shrub Medium Tree	65 49
Heliconia Heliconia spp. Perennial	101

Hercules' Club Zanthoxylum clava-herculis Medium Tree	51
Hibiscus Hibiscus spp. Large Shrub	66
Hickories Carya spp. Large Tree	42
Hidden Lily Curcuma spp. Perennial	99

Holly Fern Cyrtomium falcatum Fern Groundcover	94 82
Holly Grape Mahonia fortunei Small Shrub	75
Honeysuckle Lonicera sempervirens Vine	79
Hopbush Dodonaea viscosa Small Tree	55

Horizontal Juniper Juniperus horizontalis and cvs. Groundcover	84
Horned Holly Ilex cornuta and cvs. Large Shrub Small Tree	67 56
Hurricane Lily Lycoris spp. Perennial	104
Hydrangea Hydrangea macrophylla Large Shrub	66

I

Impatiens Impatiens spp. Annual Perennial	109 102
---	------------

Indian Hawthorn Raphiolepis spp. and cvs. Small Shrub Small Tree	76 58
--	----------

Indian Wood-oats Chasmanthium latifolium Grass	86
Inkberry Scaevola plumieri Groundcover	85

Ixora Ixora coccinea Small Shrub	75
---	----

J

Jaboticaba Myrciaria cauliflora Small Tree	57
Jacaranda Jacaranda mimosifolia Medium Tree	50
Jacobeian Lily Sprekelia formosissima Perennial	106
Jacobinia Justicia carnea Annual Perennial	109 103

Jamaica Caper Tree Capparis cynophallophora Large Shrub Small Tree	63 53
Jamaican Dogwood Piscidia piscipula Large Tree	45
Japanese Aralia Fatsia japonica Large Shrub	65
Japanese Blueberry Elaeocarpus decipiens Medium Tree	49

Japanese Juniper Juniperus chinensis and cvs. Large Shrub	68
Japanese Plum Yew Cephalotaxus harringtonia Large Shrub Small Tree	63 53
Japanese Privet Ligustrum japonicum and cvs. Large Shrub Small Tree	68 56
Japanese Yellow Jasmine Jasminum mesnyi Large Shrub	67

Jelly Palm Butia capitata Palm or Palm-Like Small Tree	88 52
Johnny-jump-up Viola spp. Annual	111
Julian's berberis Berberis julianae Large Shrub	61

K

Kalanchoe Kalanchoe blossfeldiana Perennial	103	Kentia Palm Howea forsterana Palm or Palm-Like	89	Key Thatch Palm Thrinax morrisii Palm or Palm-Like	91	King's Mantle Thunbergia erecta Large Shrub	72
--	-----	---	----	---	----	--	----

L

Lacebark Elm Ulmus parvifolia and cvs. Large Tree	47	Leatherleaf Fern Rumohra adiantiformis Fern Groundcover	95 85	Lindheimer's Beeblossom Gaura lindheimeri Perennial	101	Long Key Locustberry Byrsonima lucida Large Shrub	62
Lady Margaret Passionflower Passiflora Vine	80	Leatherwood Cyrilla racemiflora Large Shrub Small Tree	65 55	Lindley's Butterfly Bush Buddleja lindleyana Large Shrub	62	Longleaf Pine Pinus palustris Large Tree	45
Lady of the Night Brunfelsia americana Small Shrub	74	Lemongrass Cymbopogon citratus Grass	86	Lion's Ear Leonotis leonurus Perennial	103	Loquat Eriobotrya japonica Small Tree	55
Lady Palm Rhaps excelsa Palm or Palm-Like	90	Licuala Palm Licuala grandis Palm or Palm-Like	89	Little Blue Stem Grass Schizachyrium scoparium Grass	87	Loropetalum Loropetalum chinense and cvs. Large Shrub	68
Laurelleaf Snailseed Cocculus laurifolius Large Shrub	64	Ligustrum Ligustrum japonicum and cvs. Large Shrub Small Tree	68 56	Live Oak Quercus virginiana Large Tree	47	Louisiana Iris Iris hexagona Perennial	102
Leather Fern Acrostichum danaeifolium Fern Large Shrub Perennial	94 60 96	Lily of the Nile Agapanthus africanus Perennial	96	Loblolly Bay Gordonia lasianthus Large Tree	43	Lychee Litchi chinensis Large Tree	44
				Loblolly Pine Pinus taeda Large Tree	45		

M

Macarthur Palm Ptychosperma macarthurii Palm or Palm-Like	90	Mallows Hibiscus spp. Large Shrub	66	Maypop Passiflora incarnata Vine	80	Mondo Grass Ophiopogon japonicus and cvs. Groundcover	84
Madagascar Periwinkle Catharanthus roseus Annual Perennial	108 98	Mandevilla Mandevilla cvs. Vine	79	Mexican Heather Cuphea hyssopifolia Perennial	99	Morning Glory Ipomoea spp. Vine	79
Madagascar Widow's Thrill Kalanchoe blossfeldiana Perennial	103	Marlberry Ardisia escallonioides Large Shrub Small Tree	61 52	Mexican Sago Dioon edule Palm or Palm-Like	89	Muhly Grass Muhlenbergia capillaris Grass	87
Mahogany Fern Didymochlaena truncatula Fern Perennial	94 99	Marigold Tagetes spp. Annual	110	Mexican Sunflower Tithonia rotundiflora Annual	110	Musclewood Carpinus caroliniana Medium Tree	48
Maidenberry Crossopetalum rhacoma Small Tree	55	Marlberry Ardisia escallonioides Large Shrub Small Tree	61 52	Milkweed Asclepias spp. Perennial	97	Mustard Tree Capparis cynophallophora Large Shrub Small Tree	63 53
Majesty Palm Ravenea rivularis Palm or Palm-Like	90	Mary Nell Holly Ilex X'Mary Nell' Large Shrub Small Tree	67 55	Miniature Fishtail Palm Chamaedorea spp. Palm or Palm-Like	89		
				Miniature Holly Malpighia coccigera Small Shrub	75		

N

Narrowleaf Sunflower

Helianthus angustifolius
Perennial 101

Natal Plum

Carissa macrocarpa
Large Shrub 3
Small Shrub 74

Necklace Pod

Sophora tomentosa
Small Tree 59

Needle Palm

Rhapidophyllum hystrix
Palm or Palm-Like 90

Nellie R. Stevens Holly

Ilex X'Nellie R. Stevens'
Small Tree 55

Northern Sea Oats

Chasmanthium latifolium
Grass 86

Northern Slash Pine

Pinus elliottii var. *elliottii*
Large Tree 45

Nosegay

Plumeria rubra
Small Tree 58

Nuttall Oak

Quercus nuttallii
Large Tree 46

O

Oakleaf Hydrangea

Hydrangea quercifolia
Large Shrub 67

Oblongleaf Snakeherb

Dyschoriste oblongifolia
Groundcover 83
Perennial 100

Oklahoma Redbud

Cercis reniformis
Small Tree 53

Oleander

Nerium oleander
Large Shrub 69

Olive

Olea europaea
Small Tree 57

Orange Jasmine

Murraya paniculata
Large Shrub 69

Orange Jessamine

Cestrum aurantiacum
Large Shrub 63
Murraya paniculata
Large Shrub 69

Orange Plum

Justicia spicigera
Annual 109
Perennial 103

Oregon Hollygrape

Mahonia bealei
Large Shrub 68

Overcup Oak

Quercus lyrata
Medium Tree 51

Oxhorn Bucida

Bucida buceras
Large Tree 42

P

Panic Grass

Panicum virgatum and cvs.
Grass 87

Pansy

Viola Xwittrockiana
Annual 111

Paperplant

Fatsia japonica
Large Shrub 65

Paradise Tree

Simarouba glauca
Large Tree 47

Passion Vine

Passiflora incarnata
Vine 80

Paurotis Palm

Acoelorrhaphe wrightii
Palm or Palm-Like 88

Pawpaw

Asimina spp.
Large Shrub 61
Perennial 97

Peacock Ginger

Kaempferia spp.
Perennial 103

Pecan

Carya spp.
Large Tree 42

Pentas

Pentas lanceolata
Annual 110
Perennial 105

Peregrina

Jatropha integerrima
Large Shrub 68
Small Tree 56

Perennial Peanut

Arachis glabrata
Groundcover 82

Periwinkle

Catharanthus roseus
Annual 108
Perennial 98

Persian Shield

Strobilanthes dyerianus
Perennial 107

Petunia

Petunia Xhybrida
Annual 110

Philodendron

Philodendron cvs.
Large Shrub 70
Philodendron spp. and cvs.
Perennial 105

Pigeonberry

Duranta erecta
Large Shrub 65

Pigeonplum

Coccoloba diversifolia
Medium Tree 49

Pindo Palm

Butia capitata
Palm or Palm-Like 88
Small Tree 52

Pineapple Guava

Acca sellowiana
Large Shrub 60

Pine Cone Ginger

Zingiber zerumbet
Pine Cone Ginger
Perennial 107

Pineland Lantana

Lantana depressa
Small Shrub 75

Pink Allamanda

Mandevilla cvs.
Vine 79

Pink Powderpuff

Calliandra emarginata
Small Shrub 74

Pink Trumpet Tree

Tabebuia heterophylla
Medium Tree 51

Pinwheel Flower

Tabernaemontana divaricata
Large Shrub 72

Pinxter Azalea

Rhododendron canescens
Large Shrub 71

Pipestem

Agarista populifolia
Large Shrub 60

Pipevine

Aristolochia spp.
Vine 78

Pittosporum

Pittosporum tobira cvs.
Large Shrub 70

Plectranthus

Plectranthus spp.
Perennial 105

Plumbago

Plumbago auriculata cvs.
Perennial 105

Podocarpus

Podocarpus macrophyllus and cvs.
Large Shrub 70
Small Tree 58

Poinciana

Caesalpinia spp. and cvs.
Medium Tree 48
Small Shrub 74

Pond Cypress

Taxodium spp.
Large Tree 47

Ponytail Palm Nolina recurvata Palm or Palm-Like	90	Possumhaw Ilex decidua Small Tree	56	Primrose Jasmine Jasminum mesnyi Large Shrub	67	Purple Glory Tree Tibouchina granulosa Large Shrub	72
Pop Ash Fraxinus caroliniana Large Tree	43	Pot Marigold Calendula spp. Annual	108	Purple Coneflower Echinacea purpurea Perennial	100	Purple Lovegrass Eragrostis spectabilis Grass	86
Porterweed Stachytarpheta spp. Perennial	106	Powderpuff Calliandra spp. and cvs. Small Tree Mimosa strigillosa Groundcover	52 84	Purple Fountain Grass Pennisetum setaceum Grass	87	Purple Trumpet Tree Tabebuia impetiginosa Medium Tree	51

Q

Queen's Wreath Petrea volubilis Vine	80
---	----

R

Railroad Vine Ipomoea pes-caprae Vine	79	Red Cedar Juniperus virginiana Large Tree	43	River Oats Chasmanthium latifolium Grass	86	Royal Palm Roystonea regia Palm or Palm-Like	91
Rain Lily Zephyranthes spp. Perennial	107	Red-hot Cattail Acalypha hispida Small Shrub	74	Rose Rosa spp. Small Shrub	76	Royal poinciana Delonix regia Medium Tree	49
Rain-of-Gold Galphimia glauca Large Shrub	65	Red Mangrove Rhizophora mangle Medium Tree	51	Rosemary Rosmarinus spp. Small Shrub	76	Rudbeckia Rudbeckia fulgida Annual Perennial	110 105
Rangoon Creeper Quisqualis indica Vine	80	Red Maple Acer rubrum Large Tree	42	Rotund Holly Ilex rotunda Medium Tree	50	Ruffled Fan Palm Licuala grandis Palm or Palm-Like	89
Red Bay Persea borbonia Medium Tree	50	Red Powderpuff Calliandra haematocephala Large Shrub	62	Round Holly Ilex rotunda Medium Tree	50	Rusty Blackhaw Viburnum rufidulum Large Shrub Small Tree	73 59
Red Buckeye Aesculus pavia Small Tree	52	Reeve's Spirea Spiraea spp. Small Shrub	76	Roundleaf Holly Ilex rotunda Medium Tree	50	Rusty Lyonia Lyonia ferruginea Large Shrub	68
		River Birch Betula nigra Large Tree	42	Royal Fern Osmunda regalis Fern	95		

S

Sabal Palm Sabal palmetto Palm or Palm-Like	79	Salt Grass Distichlis spicata Grass	86	Sand Pine Pinus clausa Large Tree	44	Sasanqua Camellia Camellia sasanqua Large Shrub Small Tree	63 53
Sage Salvia spp. Perennial	106	Salvia Salvia spp. Perennial	106	Sargent's Palm Pseudophoenix sargentii Palm or Palm-Like	90	Satinleaf Chrysophyllum oliviforme Medium Tree	48
Salt-bush Baccharis halimifolia Large Shrub Small Tree	61 52	Sandankwa Viburnum Viburnum suspensum Large Shrub	73	Sasanqua Camellia sasanqua Large Shrub Small Tree	63 53	Saucer Magnolia Magnolia Xsoulangiana and cvs. Small Tree	57
		Sand Live Oak Quercus geminata Small Tree	58				

Saw Cabbage Palm <i>Acoelorrhaphes wrightii</i> Palm or Palm-Like	88	Shortleaf Fig <i>Ficus citrifolia</i> Medium Tree	49	Southern Blackhaw <i>Viburnum rufidulum</i> Large Shrub	73	Star Jasmine <i>Trachelospermum jasminoides</i> Groundcover	85
				Small Tree	59	Vine	80
Saw Fern <i>Blechnum serrulatum</i> Fern	94	Shrimp Plant <i>Justicia brandegeana</i> Annual	109	Southern Magnolia <i>Magnolia grandiflora</i> and cvs. Large Tree	44	St. Augustinegrass <i>Stenotaphrum secundatum</i> Turfgrass	112
Perennial	97	Perennial	102	Southern Maidenhair Fern <i>Adiantum capillus-veneris</i> Fern	94	St. Bernard's Lily <i>Anthericum sanderi</i> Groundcover	82
Saw Palmetto <i>Serenoa repens</i> Palm or Palm-Like	91	Shumard Oak <i>Quercus shumardii</i> Large Tree	46	Perennial	96	Stiff Cornel <i>Cornus foemina</i> Small Tree	54
Sawtooth Oak <i>Quercus acutissima</i> Large Tree	45	Silver Buttonwood <i>Conocarpus erectus</i> Large Shrub	64	Southern Red Cedar <i>Juniperus silicicola</i> Medium Tree	50	Stiff Dogwood <i>Cornus foemina</i> Small Tree	54
Scarletbush <i>Hamelia patens</i> Large Shrub	66	Large Tree	42	Southern Red Oak <i>Quercus falcata</i> Large Tree	46	St. James Lily <i>Sprekelia formosissima</i> Perennial	106
Scorpion Tail <i>Heliotropium angiospermum</i> Perennial	102	Silverleaf <i>Leucophyllum frutescens</i> Small Shrub	75	Southern Shield Fern <i>Thelypteris kunthii</i> Fern	95	Stokes' Aster <i>Stokesia laevis</i> Perennial	106
Scrub Mints <i>Conradina</i> spp. Perennial	98	Silver Palm <i>Coccothrinax argentata</i> Palm or Palm-Like	89	Groundcover	85	Stoppers <i>Eugenia</i> spp. Large Shrub	65
Scrub Palmetto <i>Sabal etonia</i> Palm or Palm-Like	91	Silver Trumpet Tree <i>Tabebuia aurea</i> Small Tree	89	Southern Slash Pine <i>Pinus elliottii</i> var. <i>densa</i> Large Tree	45	Small Tree	55
Small Shrub	76	Simpson's Stopper <i>Myrcianthes fragrans</i> Large Shrub	69	Southern Sugar Maple <i>Acer barbatum</i> Large Tree	42	Strangler Fig <i>Ficus aurea</i> Large Tree	42
Seagrape <i>Coccoloba uvifera</i> Large Shrub	64	Small Tree	57	Spanish Oak <i>Quercus falcata</i> Large Tree	46	Sunshine Mimosa <i>Mimosa strigillosa</i> Groundcover	84
Small Tree	54	Skyflower <i>Duranta erecta</i> Large Shrub	65	Sparkleberry <i>Vaccinium arboreum</i> Large Shrub	72	Swamp Bay <i>Persea palustris</i> Medium Tree	51
Sea Myrtle <i>Baccharis halimifolia</i> Large Shrub	61	Slender Lady Palm <i>Rhapis humilis</i> Palm or Palm-Like	91	Spider Lily <i>Hymenocallis</i> spp. Perennial	102	Swamp Chestnut Oak <i>Quercus michauxii</i> Large Tree	46
Small Tree	52	Small-Leaf Confederate Jasmine <i>Trachelospermum asiaticum</i> Groundcover	85	Spiral Ginger <i>Costus</i> spp. Perennial	98	Swamp Cyrilla <i>Cyrilla racemiflora</i> Large Shrub	65
Selloum <i>Philodendron bipinnatifidum</i> Large Shrub	70	Small Sand Live Oak <i>Quercus geminata</i> Small Tree	58	Spotted Beebalm <i>Monarda punctata</i> Annual	109	Small Tree	55
Sentry Palm <i>Howea forsterana</i> Palm or Palm-Like	89	Snake Lily <i>Amorphophallus</i> spp. Perennial	97	Spotted Horsemint <i>Monarda punctata</i> Annual	109	Swamp Dogwood <i>Cornus foemina</i> Small Tree	54
Seven Weeks Fern <i>Rumohra adiantiformis</i> Fern	95	Snowbush <i>Breynia disticha</i> Small Shrub	74	Spruce Pine <i>Pinus glabra</i> Large Tree	45	Swamp Fern <i>Blechnum serrulatum</i> Fern	94
Groundcover	85	Society Garlic <i>Tulbaghia violacea</i> Perennial	107	Star Anise <i>Illicium</i> spp. Large Shrub	57	Perennial	97
Shell Flower <i>Alpinia</i> spp. Perennial	96	Solitaire Palm <i>Ptychosperma elegans</i> Palm or Palm-Like	90	Small Tree	56	Swamp Sunflower <i>Helianthus angustifolius</i> Perennial	101
Shell Ginger <i>Alpinia</i> spp. Perennial	96	Solitary Palm <i>Ptychosperma elegans</i> Palm or Palm-Like	90	Starflower <i>Pentas lanceolata</i> Annual	110	Sweet Acacia <i>Acacia farnesiana</i> Large Shrub	60
Shiny Lyonia <i>Lyonia lucida</i> Small Shrub	75			Perennial	105	Small Tree	52
Shore Juniper <i>Juniperus conferta</i> and cvs. Groundcover	83						

Sweet Almond Bush <i>Aloysia virgata</i> Large Shrub	61
Sweet Alyssum <i>Lobularia maritima</i> Annual	109
Sweet Bay Magnolia <i>Magnolia virginiana</i> and cvs. Large Tree	44

Sweetgum <i>Liquidambar styraciflua</i> Large Tree	43
Sweet Osmanthus <i>Osmanthus fragrans</i> Large Shrub	69
Sweet Pepperbush <i>Clethra alnifolia</i> Large Shrub	64

Sweet Potato Vine <i>Ipomoea</i> spp. Groundcover	83
Sweet Viburnum <i>Viburnum odoratissimum</i> Large Shrub	73
Small Tree	59

Sword Fern <i>Nephrolepis exaltata</i> Fern	95
Groundcover	84
Sycamore <i>Platanus occidentalis</i> Large Tree	45

T

Taiwan Cherry <i>Prunus campanulata</i> Small Tree	58
Tampa Mock Vervain <i>Glandularia tampensis</i> Groundcover	83
Tampa Vervain <i>Glandularia tampensis</i> Groundcover	83
Tasmanian Tree Fern <i>Dicksonia antarctica</i> Fern	94
Perennial	94
Tea Olive <i>Osmanthus fragrans</i> Large Shrub	69
Templetree <i>Plumeria rubra</i> Small Tree	58
Ternstroemia <i>Ternstroemia gymnanthera</i> Large Shrub	72
Texas Olive <i>Cordia boissieri</i> Small Tree	54

Texas Ranger <i>Leucophyllum frutescens</i> Small Shrub	75
Texas Sage <i>Leucophyllum frutescens</i> Small Shrub	75
Thryallis <i>Galphimia glauca</i> Large Shrub	65
Tickseed <i>Coreopsis</i> spp. Annual	109
Perennial	98
Ti plant <i>Cordylina</i> spp. & cvs. Large Shrub	64
Titi <i>Cyrilla racemiflora</i> Large Shrub	65
Small Tree	55
Toothed Midsorus Fern <i>Blechnum serrulatum</i> Fern	94
Perennial	97

Treasure Flower <i>Gazania</i> spp. Annual	109
Perennial	101
Tree Maidenhair Fern <i>Didymochlaena truncatula</i> Fern	94
Perennial	99
Tree Philodendron <i>Philodendron bipinnatifidum</i> Large Shrub	70
Trumpet Creeper <i>Campsis radicans</i> Vine	78
Trumpet Flower <i>Bignonia capreolata</i> Vine	78
Trumpet Vine <i>Campsis radicans</i> Vine	78
Tulip Poplar <i>Liriodendron tulipifera</i> Large Tree	44
Tulip Tree <i>Liriodendron tulipifera</i> Large Tree	44

Tupelo <i>Nyssa sylvatica</i> Large Tree	44
Turkey Oak <i>Quercus falcata</i> Large Tree	46
Turkey Tangle Fogfruit <i>Phyla nodiflora</i> Groundcover	84
Turk's cap <i>Malvastrum arboreus</i> Large Shrub	68
Twinberry <i>Myrcianthes fragrans</i> Large Shrub	69
Small Tree	57
Twin Flower <i>Dyschoriste oblongifolia</i> Groundcover	83
Perennial	100
Two-wing Silverbell <i>Halesia diptera</i> Large Shrub	66

V

Vanuatu Fan Palm <i>Licuala grandis</i> Palm or Palm-Like	89
Varnish Leaf <i>Dodonaea viscosa</i> Small Tree	55
Venus' Hair Fern <i>Adiantum capillus-veneris</i> Fern	94

Perennial	96
Vinca <i>Catharanthus roseus</i> Annual	108
Perennial	98
Violet <i>Viola</i> spp. Annual	111

Virginia Iris <i>Iris virginica</i> Perennial	102
Virginia Sweetspire <i>Itea virginica</i> Large Shrub	67
Virginia Willow <i>Itea virginica</i> Large Shrub	67

Voodoo Lily <i>Amorphophallus</i> spp. Perennial	97
---	----

W

Walking Iris

Neomarica gracilis
Perennial 104

Walter's Viburnum

Viburnum obovatum and cvs.
Large Shrub 73
Small Tree 59

Washington Palm

Washingtonia robusta
Palm or Palm-Like 92

Water Ash

Fraxinus caroliniana
Large Tree 43

Wax Begonia

Begonia Xsemperflorescultorum
Annual 108
Perennial 97

Wax Myrtle

Myrica cerifera and cvs.
Large Shrub 69
Small Tree 57

Weeping Fern Pine

Podocarpus gracilior
Large Shrub 70
Medium Tree 51

Weeping Lantana

Lantana depressa
Small Shrub 75

Weeping Podocarpus

Podocarpus gracilior
Large Shrub 70
Medium Tree 51

Weeping Yew

Podocarpus gracilior
Large Shrub 70

West Indian Mahogany

Swietenia mahagoni
Large Tree 47

Whirling Butterflies

Gaura lindheimeri
Perennial 101

White Ash

Fraxinus americana
Large Tree 43

White Bird of Paradise

Strelitzia nicolai
Large Shrub 72

White Gaura

Gaura lindheimeri
Perennial 101

White Geiger

Cordia boissieri
Small Tree 54

White Oak

Quercus alba
Large Tree 46

Wild Banyan Tree

Ficus citrifolia
Medium Tree 49

Wild Cinnamon

Canella winterana
Small Tree 53

Wild Coffee

Psychotria nervosa
Large Shrub 70

Wild Hydrangea

Hydrangea arborescens
Large Shrub 66

Wild Olive

Osmanthus americanus
Large Shrub 69
Small Tree 57

Wild Sage

Lantana involucrata
Perennial 103

Wild Tamarind

Lysiloma latisiliquum
Large Tree 44

Windmill Palm

Trachycarpus fortunei
Palm or Palm-Like 92

Winged Elm

Ulmus alata
Large Tree 47

Wintergreen Barberry

Berberis julianae
Large Shrub 61

Wiregrass

Aristida stricta var. beyrichiana
Grass 86

Wishbone Flower

Torenia fournieri
Annual 111

Wood Vamp

Decumaria barbara
Vine 78

Y

Yaupon Holly

Ilex vomitoria and cvs.
Large Shrub 67
Small Tree 56

Yellow Butterfly Palm

Dypsis lutescens
Palm or Palm-Like 89

Yellow Jasmine

Gelsemium sempervirens
Vine 78

Yellow Poplar

Liriodendron tulipifera
Large Tree 44

Yellow Shrimp Plant

Barleria micans
Large Shrub 61

Yellow Tab

Tabebuia aurea
Small Tree 59

Yellowtop

Flaveria linearis
Perennial 100

Yellow Trumpet Tree

Tabebuia chrysostricha
Medium Tree 51

Yesterday-Today-and-Tomorrow

Brunfelsia grandiflora
Large Shrub 62

Yucca

Yucca spp.
Large Shrub 73

Z

Zebra Grass

Miscanthus sinensis
Grass 86

Zephyr Lily

Zephyranthes spp.
Perennial 107

Zinnia

Zinnia hybrids
Annual 111

Zoysiagrass

Zoysia japonica
Turfgrass 112

REFERENCES AND ADDITIONAL INFORMATION

Black, R.J. and E.F. Gilman. 2004. *Landscape Plants for the Gulf and South Atlantic Coasts*. University Press of Florida, Gainesville. 230 pp.

Broschat, T.K. and A.W. Meerow. 1999. *Betrock's Reference Guide to Florida's Landscape Plants*. Betrock Information Systems, Inc., U.S.A. 428 pp.

Dehgan, B. 1998. *Landscape Plants for Subtropical Climates*. University Press of Florida, Gainesville. 638 pp

Floridata Plant Profiles. 2005. <http://Floridata.com>

Florida Department of Environmental Protection. 2008. *Florida Green Industries Best Management Practices for Protection of Water Resources in Florida*.

Florida Department of Environmental Protection and University of Florida. 2009. *Florida-friendly Landscape Guidance Models for Ordinances, Covenants, and Restrictions*.

Florida Department of Environmental Protection and University of Florida. 2009. *The Florida-Friendly Landscaping™ Handbook for Home Landscapes*.

Haehle, R.G. and J. Brookwell. 2004. *Native Florida Plants*. Taylor Trade Publishing, New York. 400 pp.

Meerow, A.W. 1999. *Betrock's Guide to Landscape Palms*. Betrock Information Systems. Hollywood, FL. 138 pp.

Nelson, G. 2003. *Florida's Best Native Landscape Plants*. University Press of Florida, Gainesville. 411 pp.

Osorio, R. 2001. *A Gardener's Guide to Florida's Native Plants*. University Press of Florida, Gainesville. 345 pp.

USDA, NRCS. 2005. *The Plants Database, Version 3.5* (<http://plants.usda.gov>). Data compiled from various sources by Mark W. Skinner. National Plant Data Center, Baton Rouge LA 70874-4490 USA.

Watkins, J., T.J. Sheehan, and R.J. Black. 2005. *Florida Landscape Plants, Native and Exotic, 2nd Ed*. University Press of Florida, Gainesville. 468 pp.

University of Florida Environmental Horticulture Department, Woody Ornamental Landscape pages by Ed Gilman. 2009. <http://hort.ifas.ufl.edu/woody>

PHOTO CREDITS

Bowden, Robert.

Small Trees: Arenga engleri, Magnolia figo, Prunus campanulata, Tabebuia aurea.

Large Shrubs: Agarista populifolia, Agave spp., Aloysia virgata, Barleria micans, Callicarpa americana, Cestrum aurantiacum, Erythrina herbacea, Galphimia glauca, Gardenia jasminoides, Malvaviscus arboreus, Philodendron selloum, Psychotria nervosa, Rhododendron cvs., Sabal minor, Severinia buxifolia, Tabernaemontana divaricata, Thunbergia erecta, Viburnum suspensum.

Small Shrubs: Aloe spp., Malpighia coccigera, Pyracantha coccinea, Sabal etonia, Spiraea spp.

Vines: Aster carolinianus, Aristolochia spp., Bignonia

capreolata, Hedera canariensis, Hedera helix, Petraea volubilis, Trachelospermum jasminoides, Wisteria frutescens.

Groundcovers: Anthericum sanderii, Arachis glabrata, Evolvulus glomeratus, Hedera canariensis, Hedera helix, Juniperus conferta, Trachelospermum asiaticum, Trachelospermum jasminoides, Zamia pumila.

Grasses: Chasmanthium latifolium, Panicum virgatum, Paspalum quadrifarium, Thyssenolanea maxima, Tripsacum dactyloides.

Palms and Palm-Like Plants: Arenga engleri, Chamaedorea spp., Licuala grandis, Ptychosperma macarthurii, Rhapsis excelsa, Rhapsis humilis, Sabal etonia, Sabal minor, Zamia pumila.

Perennials: Agave spp., Aloe spp., Alpinia spp., Angelonia angustifolia, Belamcanda chinensis, Bromeliaceae genera, Bulbine frutescens, Crossandra spp., Curcuma spp., Dianella spp., Dietes iridoides, Echinacea purpurea, Evolvulus glomeratus, Gaura lindheimeri, Gloriosa spp., Hedychium spp., Helianthus debilis, Hippeastrum spp., Iris hexagona, Justicia spicigera, Kaempferia spp., Leonotis leonurus, Pachystachys lutea, Plectranthus spp., Rudbeckia hirta, Solenostemon scutellaroides, Stokesia laevis, Zephyranthes spp.

Annuals: Amaranthus spp., Angelonia angustifolia, Calendula spp., Justicia spicigera, Pachystachys lutea, Petunia Xhybrida, Rudbeckia hirta, Solenostemon scutellaroides, Torenia fournieri, Viola spp., Zinnia hybrids.

Brown, Stephen.

Small Trees: Baccharis halimifolia, Sophora tomentosa.

Large Shrubs: Acrostichum danaeifolium, Allamanda nerifolia, Baccharis halmifolia, Jasminum nitidum.

Groundcovers: Ernodea littoralis, Scaevola plumieri

Grasses: Cymbopogon citratus.

Ferns: Acrostichum danaeifolium, Blechnum serrulatum.

Perennials: Acrostichum danaeifolium, Blechnum serrulatum, Heliotropium angiospermum, Hymenocallis spp.

Caldwell, Doug.

Medium Trees: Elaeocarpus decipens.

Davis, Jim.

Perennials: Euryops spp.

Delvalle, Terry.

Grasses: Schizachyrium scoparium.

Durr, Audrey.

Medium Trees: Avicennia germinans.

Ferns: Sphaeropteris cooperi.

Friday, Theresa.

Perennials: Neomarica gracilis.

Gelmis, Georgia.

Large Trees: Quercus virginiana.

Palms and Palm-Like Plants: Trachycarpus fortunei.

Perennials: Sphaeropteris cooperi

Gillman, Ed.

Large Trees: Acer barbatum, Acer rubrum, Betula nigra, Bucida buceras, Carya spp., Chorisia speciosa, Conocarpus erectus, Ficus aurea, Fraxinus americana, Fraxinus caroliniana, Fraxinus pennsylvanica, Gordonia lasianthus, Halesia carolina, Juniperus virginiana, Liquidambar styraciflua, Liriodendron tulipifera, Litchi chinensis, Lysiloma latisiliquum, Magnolia grandiflora, Magnolia virginiana, Nyssa sylvatica, Persea americana, Pinus clausa, Pinus elliottii var densa, Pinus glabra, Pinus palustris, Pinus taeda, Piscidia piscipula, Platanus occidentalis, Quercus acutissima, Quercus alba, Quercus austrina, Quercus falcata, Quercus michauxii, Quercus nuttallii, Quercus shumardii, Simarouba glauca, Swietenia mahagoni, Taxodium spp., Ulmus alata, Ulmus americana, Ulmus crassifolia, Ulmus parvifolia.

Medium Trees: Bursera simaruba, Caesalpinia spp, Carpentaria acuminata,

- Carpinus caroliniana, Cassia fistula, Cercis canadensis, Chrysophyllum oliviforme, Cocoloba diversifolia, Cordia sebestena, Crataegus spp., Cypressus arizonica var. arizonica, Ficus citrifolia, Illex Xattenuata, Illex cassine, Illex opaca, Illex rotunda, Jacaranda mimosifolia, Juniperus silicicola, Lagerstroemia indica, Ostrya virginiana, Persea borbonia, Podocarpus gracilior, Quercus lyrata, Rhizophora mangle, Tabebuia chrysotricha, Tabebuia heterophylla, Tabebuia impetiginosa.
- Small Trees: Acacia farnesiana, Aesculus pavia, Aralia spinosa, Ardisia escallonioides, Butia capitata, Callistemon spp., Camellia japonica, Camellia sasanqua, Canella winterana, Capparis cynophallophora, Cephalanthus occidentalis, Cornus florida, Eriobotrya japonica, Eugenia spp., Forestiera segregata, Illex X'Nellie R. Stevens', Illex cornuta, Illex decidua, Illex vomitoria, Jatropha integerrima, Ligustrum japonicum, Magnolia Xsoulangiana, Musa spp., Myrcianthes fragrans, Myrica cerifera, Olea europaea, Osmanthus americanus, Parkinsonia aculeata, Plumeria rubra, Podocarpus macrophyllus, Prunus angustifolia, Prunus umbellata, Quercus geminata, Raphiolepis spp., Senna polyphylla, Sideroxylon spp., Tecoma stans, Viburnum obovatum, Viburnum odoratissimum, Viburnum odoratissimum var awabuki, Viburnum rufidulum.
- Large Shrubs: Abelia Xgrandiflora, Acacia farnesiana, Acca sellowiana, Aralia spinosa, Ardisia escallonioides, Asimina spp., Brugmansia Xcandida, Brunfelsia grandiflora, Buddlejia lindleyana, Calliandra haematocephala, Camellia japonica, Camellia sasanqua, Capparis cynophallophora, Carissa macrocarpa, Cephalanthus occidentalis, Cephalotaxus harringtonia, Chrysobalanus icaco, Citharexylum spinosum, Coccoloba uvifera, Coccilus laurifolius, Codiaeum variegatum, Conocarpus erectus, Cordyline spp., Crataegus spp., Duranta erecta, Eugenia spp., Fatsia japonica, Forestiera segregata, Halesia diptera, Hamamelis virginiana, Hydrangea macrophylla, Hydrangea quercifolia, Illex cornuta, Illex vomitoria, Itea virginica, Jatropha integerrima, Juniperus chinensis, Ligustrum japonicum, Loropetalum chinense, Mahonia bealei, Murrya paniculata, Musa spp., Myrcianthes fragrans, Myrica cerifera, Nerium oleander, Osmanthus americanus, Philodendron cvs., Podocarpus gracilior, Podocarpus macrophyllus, Rhamnus caroliniana, Senna polyphylla, Strelitzia nicolai, Tecoma stans, Tibouchina urvilleana, Tibouchina granulosa, Vaccinium arboreum, Viburnum obovatum, Viburnum odoratissimum, Viburnum odoratissimum var awabuki, Yucca spp.
- Small Shrubs: Breynia disticha, Caesalpinia spp., Ixora coccinea, Mahonia fortunei, Strelitzia reginae.
- Vines: Allamanda cathartica, Bougainvillea cvs., Campsis radicans, Gelsemium sempervirens, Lonicera sempervirens.
- Groundcovers: Ajuga reptans, Aspidistra elatior, Dryopteris spp., Liriope muscari, Zamia furfuracea.
- Grasses: Miscanthus sinensis, Spartina spp., Tripsacum floridana.
- Palms and Palm-Like Plants: Acoelorrhapha wrightii, Bismarckia nobilis, Butia capitata, Carpentaria acuminata, Caryota mitis, Chamaerops humilis, Chrysalidocarpus lutescens, Coccolobina argentea, Howea forsteriana, Livistona spp., Nolina recurvata, Phoenix spp., Pseudophoenix sargentii, Ravenea rivularis, Rhipidophyllum hystrix, Roystonea regia, Sabal palmetto, Serenoa repens, Thrinax morrisii, Thrinax radiata, Washingtonia robusta, Wodyetia bifurcata, Zamia furfuracea.
- Ferns: Dryopteris spp.
- Perennials: Agapanthus africanus, Ajuga reptans, Asimina spp., Aspidistra elatior, Caladium Xhortulanum, Cuphea hyssopifolia, Dryopteris spp., Heliconia spp., Impatiens spp., Justicia brandegeana, Justicia carnea, Liriope muscari, Musa spp., Philodendron cvs., Stachytarpheta spp.
- Annuals: Ageratum spp., Caladium Xhortulanum, Celosia spp., Impatiens spp., Justicia brandegeana, Justicia carnea.
- Gaspar, Joaquim.
Large Shrubs: Nerium oleander-inset.
- Girin, Bruno.
Annuals: Viola Xwittrockiana.
- Granson, Sandy.
Small Trees: Calliandra spp., Dodonaea viscosa, Myrciaria cauliflora.
Large Shrubs: Lyonia ferruginea, Suriana maritima.
Small Shrubs: Acalypha hispida, Brunfelsia americana, Carissa macrocarpa, Gamolepis spp., Lantana depressa, Leucophyllum frutescens, Rosmarinus spp.
Vines: Ficus pumila, Thunbergia alata.
Grasses: Andropogon spp.
Ferns: Pteridium aquilinum.
Perennials: Begonia semperflorens, Hemerocallis spp., Lantana involucrata, Pteridium aquilinum.
Annuals: Begonia semperflorens, Monarda punctata.
- Green, Tim.
Ferns: Dicksonia antarctica.
Perennials: Dicksonia antarctica.
- Jacinto, Valter.
Large Shrubs: Jasminum mesnyi.
- Karekar, Kapil.
Perennials: Haemanthus multiflorus.
- Keisotyo.
Small Trees: Podocarpus macrophyllus (inset).
Large Shrubs: Podocarpus macrophyllus (inset).
- Kenpei.
Large Shrubs: Heptapleurum arboricolum, Hydrangea arborescens, Ternstroemia gymnanthera.
Small Shrubs: Raphiolepis spp.
Groundcovers: Juniperus horizontalis, Ophiopogon japonicus.
- Kern, Bill.
Medium Trees: Persea palustris.
Small Trees: Cyrilla racemiflora, Sophora tomentosa (inset).
Large Shrubs: Cyrilla racemiflora, Senna bicapsularis.
Small Shrubs: Lyonia lucida.
- Larsen, Claudia.
Large Shrubs: Calycanthus floridus, Rhododendron canescens.
Groundcovers: Glandularia tampensis, Lantana montevidensis.
Grasses: Eragrostis elliottii.
Perennials: Conradina spp., Coreopsis spp., Flaveria linearis, Gaillardia pulchella, Helianthus angustifolius, Sisyrinchium angustifolium, Solidago spp.
Annuals: Coreopsis spp.
- Murray, Ann. University of Florida/IFAS Center for Aquatic and Invasive Plants
Ferns: Osmunda cinnamomea.
Perennials: Iris virginica, Osmunda cinnamomea.
- Niemann, Brian.
Small Trees: Illex X'Mary Nell'.
Large Shrubs: Berberis julianae, Clethra alnifolia, Illex X'Mary Nell', Osmanthus fragrans, Pittosporum tobira.
Vines: Decumaria barbara.
Groundcovers: Mimosa strigillosa.
- Pagnier, Veronique.
Vines: Mandevilla cvs.
- Pellegrini, Mark.
Groundcovers: Ardisia japonica.
- Quillia, Oliver.
Vines: Passiflora incarnata (inset).
- Ramey, Vic. University of Florida/IFAS Center for Aquatic and Invasive Plants
Small Trees: Cornus foemina.
Large Shrubs: Rhododendron austrinum.
Groundcovers: Nephrolepis biserrata.

Ferns: Nephrolepis biserrata.

Richard, Amy. University of Florida/IFAS Center for Aquatic and Invasive Plants
Groundcovers: Nephrolepis exaltata.
Ferns: Nephrolepis exaltata.

Schumaker, Paul.
Groundcovers: Ipomoea spp.

Shebs, Stan.
Groundcovers: Rumohra adiantiformis.
Grasses: Aristida stricta var. beyrichiana.
Ferns: Rumohra adiantiformis.

Storch, Hedwig.
Perennials: Kalanchoe blossfeldiana.

Sullivan, Jessica.
Medium Trees: Elaeocarpus decipens, Zanthoxylum clava-herculis.

Tau'olunga.
Vines: Quisqualis indica.

Taylor, Kim.
Large Shrubs: Hamelia patens.

Wasowski, Sally and Andy. Lady Bird Johnson Wildflower Center
Groundcovers: Thelypteris kunthii.
Ferns: Thelypteris kunthii.

Wichman, Tom.
Large Shrubs: Bambusa spp., Hibiscus spp.
Vines: Millettia reticulata.
Groundcovers: Vinca major.
Palms and Palm-Like Plants: Ceratozamia hildae,
Ceratozamia kuesteriana, Dioon edule.
Perennials: Amorphophallus spp., Asclepias spp., Lycoris spp.

Wilber, Wendy.
Annuals: Tithonia rotundiflora.

Wildes, Carolyn.
Small Shrubs: Russelia sarmentosa.

Yasalonis, Anne.
Small Trees: Illicium spp.
Large Shrubs: Illicium spp., Jasminum multiflorum.
Small Shrubs: Russelia equisetiformis.
Vines: Jasminum multiflorum.
Groundcovers: Dyschoriste oblongifolia.
Perennials: Conradina spp. (inset), Dyschoriste oblongifolia.

Key to Symbols & Abbreviations

Native Status

Yes = Florida native No = Not a Florida native

Var. = Native status depends on species selection

GROWTH RATE, HEIGHT AND SPREAD:

Growth rate = Slow or Fast (if no rate is given the plant does not grow exceptionally fast or slow.)

↑ = mature height in feet ⇨ = mature spread in feet

Soil pH (Gives the Range Tolerated By the Plant):

●○○○ = Acid 4.5-5.5

●●○○ = Acid to slightly acid 4.5-6.5

●●●○ = Acid to slightly alkaline 4.5-7.2

○○○○ = Slightly acid 6.0-6.8

○●●○ = Slightly acid to slightly alkaline 6.0-7.2

○●●● = Slightly acid to alkaline 6.0-8.0

●●●● = Tolerates any soil pH 4.5-8.0

Soil Texture:

C/L = clay loam S/L = sandy loam S = sandy

S/C = sandy clay any = any texture

SOIL MOISTURE:

☾ = well drained

☾ = medium drained

● = wet

☾☾ = well drained to medium drained

☾● = medium drained to wet

☾☾● = well drained to wetvv

Drought Tolerance:

High, Medium, Low, or None

(Note: Both drought tolerance and soil moisture tolerance should be considered, and they are not the same. For example, a plant may tolerate wet soils and also have high drought tolerance, and another plant may prefer well drained soils but have low drought tolerance.)

Light Range and Light Optimum:

☀ = Full Sun ☁ = Partial Shade

☁ = Shade □ = Optimum light conditions

Salt Tolerance:

H = High M = Medium L-N = Low to None U = Unknown

Wildlife:

🦋 = Attracts butterflies

🐦 = Attracts hummingbirds

🐦 = Attracts other birds

NOTES

A series of horizontal dotted lines for writing notes, spaced evenly down the page.

A series of 15 horizontal dotted lines spaced evenly down the page, serving as a guide for handwriting practice.

NOTES

A series of horizontal dotted lines for writing notes, arranged in a repeating pattern down the page.

Create a Florida Friendly Landscape

Yards and landscapes can be a positive asset to Florida. You can design and maintain your own Florida-Friendly Landscape by following the simple practices in this book. You will learn the basics of designing a landscape featuring carefully selected plants suited to Florida's unique climate, natural conditions, and wildlife.

We offer you cost-saving tips that, if implemented properly, will help you reduce water, fertilizer, and pesticide use. There is also a helpful section for

waterfront homeowners addressing the special concerns of shoreline landscape management. Whether you are starting from scratch with a new landscape or considering changes to an existing yard, the *The Florida-Friendly Landscaping™ Handbook for Home Landscapes* offers helpful concepts, tools, and techniques for creating your own Florida-Friendly yard. We hope you enjoy the publication and look forward to assisting you in creating an aesthetically pleasing landscape that will also help to protect Florida's natural resources.

Florida-Friendly Landscaping™ Plant Guide

Find the Right Plant for the Right Place Anytime, Anywhere

fflplantguide.com

Available on the Apple Store and Google Play

